



CH-1536TXPL

HDMI over HDBaseT Transmitter
with IR/RS-232



Operation Manual

DISCLAIMERS

The information in this manual has been carefully checked and is believed to be accurate. Cypress Technology assumes no responsibility for any infringements of patents or other rights of third parties which may result from its use.

Cypress Technology assumes no responsibility for any inaccuracies that may be contained in this document. Cypress also makes no commitment to update or to keep current the information contained in this document.

Cypress Technology reserves the right to make improvements to this document and/or product at any time and without notice.

COPYRIGHT NOTICE

No part of this document may be reproduced, transmitted, transcribed, stored in a retrieval system, or any of its part translated into any language or computer file, in any form or by any means—electronic, mechanical, magnetic, optical, chemical, manual, or otherwise—without express written permission and consent from Cypress Technology.

© Copyright 2018 by Cypress Technology.

All Rights Reserved.

TRADEMARK ACKNOWLEDGMENTS

All products or service names mentioned in this document may be trademarks of the companies with which they are associated.





SAFETY PRECAUTIONS

Please read all instructions before attempting to unpack, install or operate this equipment and before connecting the power supply.

Please keep the following in mind as you unpack and install this equipment:

- Always follow basic safety precautions to reduce the risk of fire, electrical shock and injury to persons.
- To prevent fire or shock hazard, do not expose the unit to rain, moisture or install this product near water.
- Never spill liquid of any kind on or into this product.
- Never push an object of any kind into this product through any openings or empty slots in the unit, as you may damage parts inside the unit.
- Do not attach the power supply cabling to building surfaces.
- Use only the supplied power supply unit (PSU). Do not use the PSU if it is damaged.
- Do not allow anything to rest on the power cabling or allow any weight to be placed upon it or any person walk on it.
- To protect the unit from overheating, do not block any vents or openings in the unit housing that provide ventilation and allow for sufficient space for air to circulate around the unit.

REVISION HISTORY

VERSION NO.	DATE	SUMMARY OF CHANGE
VS1	09/03/18	Final technical review



CONTENTS

1. Introduction	1
2. Applications	1
3. Package Contents	1
4. System Requirements	2
5. Features	2
6. Operation Controls and Functions	4
6.1 Transmitter's Front Panel	4
6.2 Transmitter's Rear Panel.....	5
6.3 Transmitter's Right Side Panel.....	6
6.4 IR Cable Pin Assignments	6
6.5 EDID Management	7
6.5.1 EDID Dipswitch Settings	7
6.5.2 EDID Management APP.....	9
7. Connection Diagram	13
8. Specifications	14
8.1 Technical Specifications	14
8.2 Video Specifications	15
8.3 Cable Specifications	16
8.4 HDBaseT Features.....	16
9. Acronyms	17





1. INTRODUCTION

This HDMI over single Cat.5e/6/7 Transmitter is a great solution for extending uncompressed HD audio and video as well as Ethernet and control via a single run of Cat.5e/6/7 cable over distances of up to 70 meters. Multiple data and control interfaces are provided, including IR and RS-232 connections.

This extender complies with the advanced HDCP 2.2 and HDMI 2.0 standards, as well as supporting the legacy HDCP 1.x and HDMI 1.x standards. Despite HDBaseT's 10Gbps bandwidth limitation, 4K UHD HDMI video, up to and including 4K@60Hz (4:4:4), is able to be processed and extended by subsampling 4:4:4 color to 4:2:0 and reducing bit depth when necessary.

Beyond video, data, and control this unit also includes useful audio features. The Optical Audio Return (OAR) feature supports transmitting optical audio from a compatible Receiver back to the Transmitter for local playback. An audio insertion feature is also included, allowing for stereo analog audio to be embedded into the HDBaseT output signal. Rounding out the feature set is robust EDID management as well as automatic HDBaseT clock stretching and TMDS re-clocking support. Compatible Receivers (PD) may be powered by 48V PoH provided by this Transmitter (PSE), allowing for greater flexibility within different installation scenarios.

2. APPLICATIONS

- Home entertainment sharing and control
- Lecture room display and control
- Showroom display and control
- Meeting room presentation and control
- Classroom display and control

3. PACKAGE CONTENTS

- 1×HDMI over HDBaseT Transmitter
- 1×IR Blaster Cable
- 3×3-pin Terminal Blocks
- 1×48V/0.83A DC Power Adaptor

- 1×Power Cord
- 1×Rack Mount Ears (Set of 2)
- 1×Operation Manual

4. SYSTEM REQUIREMENTS

- HDMI source equipment such as a media player, video game console or set-top box.
- Industry standard Cat.6 or Cat.6a cables are recommended.
- The use of "Premium High Speed HDMI" cables is recommended.

5. FEATURES

- HDMI with 3D & 4K@60Hz support, DVI 1.0 compatible
- HDCP 2.2 and HDCP 1.x compliant
- Supports up to 4K UHD (18Gbps, 4K@60Hz 4:4:4) video input
- Supports output resolutions up to 4K@50/60Hz (YUV 4:2:0)
- Supports Deep Color input and output up to 12-bit
- Supports CEC bypass
- Simultaneous transmission of uncompressed video, audio and data over a single Cat.5e/6/7 cable up to 70m at 1080p and 35m at 4K
- Supported HDBaseT feature set: High-Definition Video and Audio, 48V PoH and Control (Bi-directional IR/RS-232 pass-through)
- Supports the output of a 720p color bar pattern when no source is connected
- Supports automatic signal down conversion to match HDBaseT bandwidth requirements
 - 4K@50/60Hz (4:4:4) → 4K@50/60Hz (YUV 4:2:0, 8-bit)
 - 4K@23/24/25/30Hz (10 or 12-bit) → 4K@23/24/25/30Hz (8-bit)
 - 4K@50/60Hz (YUV 4:2:0, 10 or 12-bit) → 4K@50/60Hz (YUV 4:2:0, 8-bit)
- Supports the Optical Audio Return (OAR) function to transmit optical audio from a compatible receiver to this transmitter
- Supports the insertion of external stereo audio into the transmitted HDBaseT signal



- Comprehensive EDID management support including 6 pre-defined EDIDs, 9 user EDIDs and an EDID bypass mode
- PC-based EDID management software allows for the uploading of customized user EDIDs via USB
- Supports HDMI DDC bus clock stretching for improved compatibility with certain Blu-ray players
- Performs TMDS re-clocking and signal re-generation for improved signal integrity
- Supports standard 48V PoH from Transmitter (PSE) to Receiver (PD) (compatible Receivers only)
- Ultra-slim case design for easy installation (only 16mm thick!)

Notes:

- *The 48V PoH function is designed for powering compatible Receiver units only—non-PoH Receivers will need their own power supply. Receivers of another brand may not be compatible.*
- *4K and 3D sources or equivalently high-bandwidth signals require an appropriate compatible display and HDMI cables in order to achieve the best image quality. The use of “Premium High Speed HDMI” cables is highly recommended.*

6. OPERATION CONTROLS AND FUNCTIONS

6.1 Transmitter's Front Panel

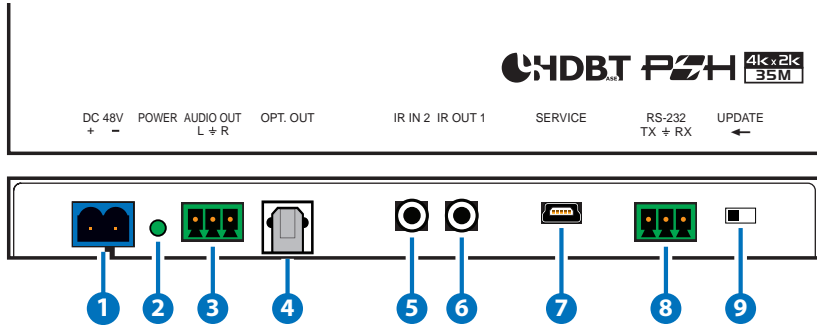

- 1 **DC 48V:** Plug the 48V DC power adapter into this port and connect it to an AC wall outlet for power. Please be sure to follow the polarity labels on the unit and the adapter's wires.
- 2 **POWER LED:** This LED will illuminate to indicate the unit is on and receiving power.
- 3 **AUDIO OUT L/R:** Use a phoenix connector adapter cable to connect to powered speakers or an amplifier for stereo analog audio output. Audio is sourced from the Optical Audio Return input on the connected Rx.
- 4 **OPT. OUT:** Connect to powered speakers or an amplifier for digital audio output using an appropriate optical cable. Audio is sourced from the Optical Audio Return input on the connected Rx.
- 5 **IR IN 2:** Connect to the provided IR Extender to extend the IR control range of remotely located devices. Ensure that the remote being used is within direct line-of-sight of the IR Extender.
- 6 **IR OUT 1:** Connect to the provided IR Blaster to transmit IR signals to devices within direct line-of-sight of the IR Blaster.
- 7 **SERVICE:** This USB 2.0 port is reserved for firmware update and user EDID upload use.
- 8 **RS-232:** Connect to a PC, laptop or other serial control device with a 3-pin adapter cable for the extension of RS-232 signals to the Receiver.

Note: Depending on the controlled device connected to the Receiver side, the Tx and Rx pins might need to be reversed.

- 9 **UPDATE:** For normal operation, this switch should be set to the right. To place the unit into firmware update mode, move the switch to the left, following the arrow direction. Once the update is successful, return the switch to the right.

6.2 Transmitter's Rear Panel

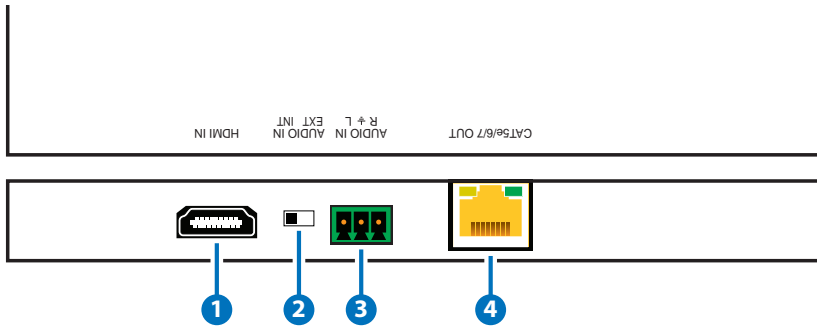

- 1 **HDMI IN:** Connect to HDMI source equipment such as a media player, game console or set-top box.
- 2 **AUDIO IN EXT/INT:** Controls the audio source for the HDBaseT output. Select "Int" to use the HDMI input's original audio. Select "Ext" to embed the analog audio from the Audio In connection on the Tx.
- 3 **AUDIO IN L/R:** Use a phoenix connector adapter cable to connect to the stereo analog output of a device such as a CD player or PC.
- 4 **CAT5e/6/7 OUT:** Connect to a compatible HDBaseT Receiver with a single Cat.5e/6/7 cable for transmission of all data signals and power.

6.3 Transmitter's Right Side Panel

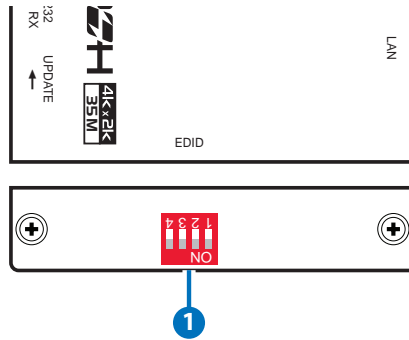

1 EDID: The EDID dipswitch block provides a way to select the EDID to use with the connected source. By using a combination of on and off settings for the dipswitches, there is a total of 16 possible EDID selections across 3 different operation modes.

The three modes are "Internal EDID", "User EDID" and "Native EDID". There are a total of 6 built-in internal EDIDs and 9 User EDIDs (which can be modified via USB upload). The Native EDID setting will copy the EDID from the sink that is connected to the Receiver. (See "EDID Management" for more details.)

6.4 IR Cable Pin Assignments

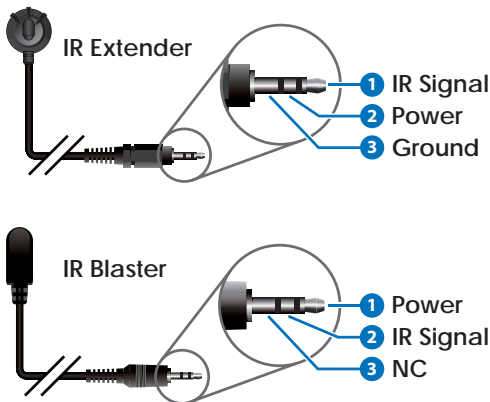

6.5 EDID Management

6.5.1 EDID Dipswitch Settings

The EDID dipswitch block provides a way to select the EDID to use with the connected source. By using a combination of on and off settings for the dipswitches, there is a total of 16 possible EDID selections across 3 different operation modes.

1 = Dipswitch in "on" (down) position

0 = Dipswitch in "off" (up) position

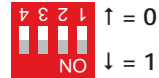

Mode	Number	Dipswitch Position
Internal EDID	1	1111
	2	1110
	3	1101
	4	1100
	5	1011
	6	1010
User EDID	1	1001
	2	1000
	3	0111
	4	0110
	5	0101
	6	0100
	7	0011
	8	0010
	9	0001
Native EDID	16	0000

Detailed EDID information:

1. Internal EDID (1-6)

There are a total of 6 built-in internal EDID slots covering many standard display configurations. These EDIDs can't be modified. They are defined as follows:

EDID	Video Content	Audio Content
FHD/2 channel	1080p@60Hz, 8-bit	LPCM 2.0 (148MHz)
FHD/Multi-channel	1080p@60Hz, 8-bit	LPCM 7.1 + Bitstream (148MHz)
UHD/2 channel	3840×2160p@30Hz, 8-bit	LPCM 2.0 (297MHz)
UHD/Multi-channel	3840×2160p@30Hz, 8-bit	LPCM 7.1 + Bitstream (297MHz)
UHD+/2 channel	3840×2160p@60Hz, up to 12-bit	LPCM 2.0 (594MHz)
UHD+/Multi-channel	3840×2160p@60Hz, up to 12-bit	LPCM 7.1 + Bitstream (594MHz)

2. User EDID (1-9)

There are a total of 9 User EDID slots which can be modified via USB upload. By default, these slots all contain the same default EDID:

EDID	Video Content	Audio Content
FHD/2 channel	1080p@60Hz, 8-bit	LPCM 2.0 (148MHz)

3. Native (External) EDID

The Native EDID setting will copy the EDID from the sink that is connected to the Receiver.

6.5.2 EDID Management APP

- (1) This unit uses an EDID Management application which allows the user to copy the EDID from an attached display, edit an existing EDID file stored on the PC or create a basic EDID from scratch. The EDID can then be uploaded to the unit for use.
- (2) Please obtain the EDID Management software from your authorized dealer and save it in a directory where you can easily find it.
- (3) Before connecting the unit to your PC, please install the appropriate Virtual COM Port Driver depending on your Windows version. Next, install the EDID Management software.
- (4) After the installation has successfully completed an icon for it will appear on the windows desktop. Launch the software by double-clicking on the icon and the EDID Management device detection window will open up on your screen.

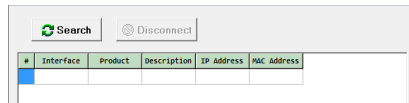

- (5) After launching the software, power the unit on and then connect it to the PC/laptop using a Mini-USB to USB cable. Click on the "Search"  button and any detected units will be displayed in the list. Clicking on a detected unit will open the EDID Commander window.



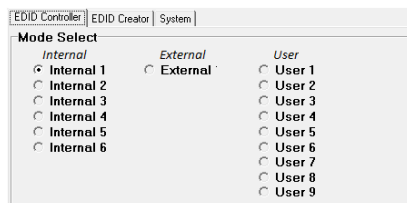

1. EDID Controller Tab

- **Mode Select:** Under the EDID Controller tab you will see the currently selected EDID slot (based on dipswitch position). The software can't change this selection, only monitor it.



- **Save/Upload/Analysis:** EDIDs may be saved, uploaded or analyzed:





- **Save:** Any EDID from the unit or a connected HDMI display can be saved to your PC as a *.bin file by selecting the EDID source from the drop down menu and then clicking the "Save"  icon.
- **Upload:** Previously saved EDID files (*.bin format) can be re-uploaded into any of the "User" EDID slots by selecting the User EDID to replace from the dropdown and then clicking the "Upload"  icon. Before accepting the upload, the software will check and verify that the EDID's header and checksum values are acceptable.
- **Analysis:** To analyze any EDID stored within the unit, select the EDID to view from the dropdown and click on the "Analysis"  icon. From the Analyzer window it is possible to open the currently analyzed EDID in the EDID Creator by clicking the "Edit"  button.



EDID Information	
EDID Header :	Good
EDID Checksum :	Good
Manufacturer Name :	STD
Monitor Name :	Emulator
Max Resolution :	2160p@30Hz
Max Color Depth :	12bit
Support 3D :	No
Support YUV420 :	No
Support SCDC :	Yes
Support 600MHz :	Yes
Support HDR :	8bit,10bit,12bit,
Audio Formats :	2PCM,
Audio Max Channel :	2CH
CEC Address :	1000



2. EDID Creator Tab

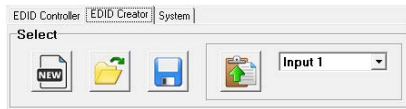

- **Select:** Click on the EDID Creator tab to begin designing a new EDID from scratch (select the “New” ), to modify an existing EDID stored on the PC as a *.bin file (select the “Load” ), or to edit an EDID copied from the unit via the EDID Analyzer’s edit option.



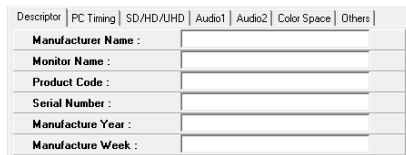

- Selecting “New”  will automatically populate the various EDID fields with basic information that can be easily edited to match the user’s preferences.
- Clicking on the “Load”  icon will open a file load window and after the *.bin file has been selected and loaded the EDID fields will be populated with the information from that file. The same will happen when the EDID is copied from the EDID Analyzer window.
- **Edit:** The following tabs provide access to a wide range of EDID information which can be edited:



- **Descriptor:** This tab allows for the editing of various description and information fields within the EDID file such as Manufacturer Name, Monitor Name, etc.
- **PC Timing & SD/HD/UHD:** These tabs allow for the selection of the resolutions and refresh rates that the EDID will report as supported.
- **Audio1 & Audio2:** These tabs allow for the selection of which audio formats, audio frequencies, channels and speaker locations are supported.
- **Color Space:** This tab allows for the selection of which color formats and bit depths are supported, including BT.2020 and HDR support options.
- **Others:** This tab contains options for supporting 3D and defining the CEC Address.

Once the user is finished editing or creating an EDID it can be saved to a *.bin file locally or uploaded directly to the unit using the “Save”  and “Upload”  icons respectively.

3. System Tab

- **Configuration & Firmware:** Select the System tab to edit the unit's description (select the “Rename”  icon), to reset the unit to factory defaults (select the “Reset”  icon) and to view the unit's current hardware and firmware version information.

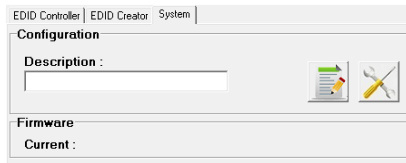

7. CONNECTION DIAGRAM

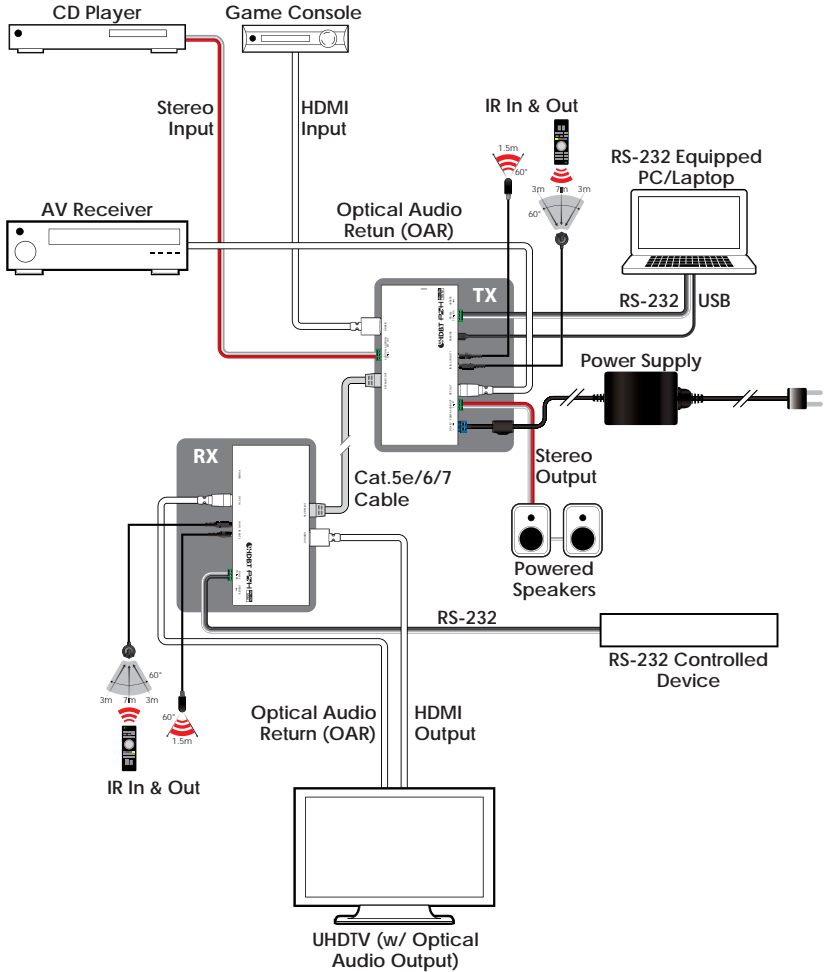

8. SPECIFICATIONS

8.1 Technical Specifications

Video Bandwidth	HDMI: 600MHz/18Gbps HDBaseT: 340MHz/10.2Gbps
Input Ports	1×HDMI 1×Terminal Block (Stereo Audio)
Output Ports	1×Cat.5e/6/7 1×Optical (S/PDIF Audio) 1×Terminal Block (Stereo Audio)
Control Interfaces	1×IR Blaster [3.5mm] 1×IR Extender [3.5mm] 1×RS-232 [Terminal Block] 1×USB Mini-B
HDMI Cable Length	10m (1080p@60Hz, 12-bit) 3m (4K@60Hz, YUV 4:4:4, 8-bit)
IR Frequency	30 - 50kHz (30 - 60kHz under ideal conditions)
Baud Rate	Up to 115200bps
Power Supply	48V/0.83A DC (US/EU standards, CE/FCC/UL certified)
ESD Protection	Human Body Model: ±12kV (Air Discharge) ±8kV (Contact Discharge)
Dimensions	163mm×16mm×78mm (W×H×D) [Case Only] 163mm×16mm×79.2mm (W×H×D) [All Inclusive]
Weight	184g
Chassis Material	Aluminum
Silkscreen Color	Black



Operating Temperature 0°C - 40°C/32°F - 104°F
Storage Temperature -20°C - 60°C/-4°F - 140°F
Relative Humidity 20 - 90% RH (Non-condensing)
Power Consumption 17.8W

8.2 Video Specifications

Supported Resolutions (Hz)	Input	Output
480p/480i@60	✓	✓
576p/576i@50	✓	✓
640×480@60/72/75/85	✓	✓
800×600@56/60/72/75/85	✓	✓
1024×768@60/70/75/85	✓	✓
1280×720p@50/60	✓	✓
1280×768@60/75/85	✓	✓
1280×800@60	✓	✓
1280×1024@60	✓	✓
1360×768@60	✓	✓
1600×1200@60	✓	✓
1920×1080i@50/60	✓	✓
1920×1080p@24/25/30/50/60	✓	✓
1920×1200@60 (RB)	✓	✓
3840×2160@24/25/30	✓	✓ (Bit depth converted to 8-bit if needed)
3840×2160@50/60 (YUV 4:2:0)	✓	
4096×2160@24/25/30	✓	
4096×2160p@50/60 (YUV 4:2:0)	✓	
3840×2160@50/60	✓	✓ (Color subsampled to YUV 4:2:0)
4096×2160@50/60	✓	

8.3 Cable Specifications

Cable Type	Cable Length	Supported Video Format
Cat.5e/6/6a/7	70 meters	Full HD video: <ul style="list-style-type: none"> • Up to 1080p@60Hz, 12-bit color • Data rates lower than 5.3Gbps or below 225MHz TMDS clock
Cat.5e/6/6a/7	35 meters	Ultra HD video: <ul style="list-style-type: none"> • 4K@24/25/30Hz & 4K@50/60Hz (YUV 4:2:0), 8-bit color • Data rates higher than 5.3Gbps or above 225MHz TMDS clock

8.4 HDBaseT Features

Features	Transmitter
Audio/Video	✓
Control (IR & RS-232)	✓
Power Source Equipment (PSE)	✓
Powered Device (PD)	
LAN	

9. ACRONYMS

ACRONYM	COMPLETE TERM
Cat.5e	Category 5 (enhanced) Cable
Cat.6	Category 6 Cable
Cat.7	Category 7 Cable
CEC	Consumer Electronics Control
DVI	Digital Visual Interface
HDCP	High-bandwidth Digital Content Protection
HDMI	High-Definition Multimedia Interface
IR	Infrared
LAN	Local Area Network
PD	Powered Device
PoH	Power over HDBaseT
PSE	Power Sourcing Equipment
S/PDIF	Sony/Philips Digital Interface Format
UHD	Ultra-High-Definition
USB	Universal Serial Bus
VGA	Video Graphics Array (640×480@60Hz)
WUXGA	Wide Ultra Extended Graphics Array (1920×1200@60Hz)



CYPRESS TECHNOLOGY CO., LTD.

www.cypress.com.tw