



CH-2535TX & CH-2535RX

HDMI/DP/VGA over HDBaseT Scaling Transmitter (PD)
& Receiver (PSE) with Control System



Operation Manual

DISCLAIMERS

The information in this manual has been carefully checked and is believed to be accurate. Cypress Technology assumes no responsibility for any infringements of patents or other rights of third parties which may result from its use.

Cypress Technology assumes no responsibility for any inaccuracies that may be contained in this document. Cypress also makes no commitment to update or to keep current the information contained in this document.

Cypress Technology reserves the right to make improvements to this document and/or product at any time and without notice.

COPYRIGHT NOTICE

No part of this document may be reproduced, transmitted, transcribed, stored in a retrieval system, or any of its part translated into any language or computer file, in any form or by any means—electronic, mechanical, magnetic, optical, chemical, manual, or otherwise—without express written permission and consent from Cypress Technology.

© Copyright 2017 by Cypress Technology.

All Rights Reserved.

TRADEMARK ACKNOWLEDGMENTS

All products or service names mentioned in this document may be trademarks of the companies with which they are associated.





SAFETY PRECAUTIONS

Please read all instructions before attempting to unpack, install or operate this equipment and before connecting the power supply.

Please keep the following in mind as you unpack and install this equipment:

- Always follow basic safety precautions to reduce the risk of fire, electrical shock and injury to persons.
- To prevent fire or shock hazard, do not expose the unit to rain, moisture or install this product near water.
- Never spill liquid of any kind on or into this product.
- Never push an object of any kind into this product through any openings or empty slots in the unit, as you may damage parts inside the unit.
- Do not attach the power supply cabling to building surfaces.
- Use only the supplied power supply unit (PSU). Do not use the PSU if it is damaged.
- Do not allow anything to rest on the power cabling or allow any weight to be placed upon it or any person walk on it.
- To protect the unit from overheating, do not block any vents or openings in the unit housing that provide ventilation and allow for sufficient space for air to circulate around the unit.

REVISION HISTORY

VERSION NO.	DATE (DD/MM/YY)	SUMMARY OF CHANGE
VS1	27/10/17	Preliminary release
VS2	19/04/18	Updated section 8.1



CONTENTS

1. Introduction	1
2. Applications	1
3. Package Contents	2
4. System Requirements	2
5. Features	3
6. Operation Controls and Functions	4
6.1 Transmitter's Top Panel	4
6.2 Transmitter's Front and Rear Panels.....	5
6.3 Receiver's Top Panel	6
6.4 Receiver's Front and Rear Panels	7
6.5 OSD Menu	9
6.6 IR Cable Pin Assignments	17
6.7 RS-232 Protocol.....	17
6.8 Telnet Control	18
6.8.1 Telnet Access	18
6.8.2 Telnet/RS-232 Commands.....	19
6.9 WebGUI Control	46
6.9.1 Device Discovery APP	46
6.9.2 WebGUI Control Page	47
7. Connection Diagram	68
8. Specifications	69
8.1 Technical Specifications	69
8.2 Video Specifications.....	72
8.2.1 Transmitter's Resolutions	72
8.2.2 Receiver's Resolutions.....	76
8.2.3 Color Sapce Conversions	80
8.2.4 Cable Specifications	80
8.3 Application Notes	81
9. Acronyms	82



1. INTRODUCTION

This new collaboration Transmitter and Receiver system is a convenient turnkey solution for video selection and extension in conference rooms, classrooms and showrooms. These units provide not only AV conversion and extension but also an intelligent and easy way to control devices throughout the entire venue. The three most common input interfaces (HDMI, DisplayPort, and VGA) are supported by the Transmitter, providing the ultimate in source compatibility and flexibility. The HDMI and DisplayPort inputs both support resolution/timing up to a maximum of 4K@60Hz (4:4:4, 8-bit) which is converted, as appropriate, for transmission over HDBaseT. The selected source can be transmitted over Cat.6/7 cable up to 70m (at 4K@60Hz). The Receiver can scale the HDBaseT video source, or local HDMI input, to match the connected display's resolution requirements.

The Transmitter also provides an interface for a remote control keypad, or trigger interface, which can be easily installed within a podium or within a table in a conference room or classroom. This interface can allow the user to control a wide range of devices by activating single commands or complex macros and sending commands out over the local network. In order to provide a more robust selection of control options, the Receiver also supports 2 relay connections, providing instant control over projector screens, curtains, lights, etc. The unique macro programmability allows for the implementation of multiple command activations from a single button press. These units are controllable via top panel controls (with OSD), WebGUI, Telnet, and RS-232.

2. APPLICATIONS

- Conference room display
- Classroom display
- Showroom display

3. PACKAGE CONTENTS

Transmitter

- 1×HDMI/DP/VGA over HDBaseT Scaling Transmitter
- 1×IR Extender Cable
- 1×IR Blaster Cable
- 2×Terminal Blocks (5-pin)
- 1×Operation Manual

Receiver

- 1×HDMI over HDBaseT Scaling Receiver
- 1×IR Extender Cable
- 1×IR Blaster Cable
- 2×Terminal Blocks (2-pin)
- 1×Terminal Block (5-pin)
- 1×24V/2.7A DC Power Adaptor
- 1×Power Cord
- 1×Operation Manual

4. SYSTEM REQUIREMENTS

- HDMI and DisplayPort source equipment such as media players, video game consoles or set-top boxes.
- VGA source equipment such as PCs, laptops or set-top boxes.
- HDMI receiving equipment such as HDTVs, monitors or audio amplifiers.
- Analog audio receiving equipment such as headphones, audio amplifiers or powered speakers.
- The use of "Premium High Speed HDMI" cables is highly recommended.
- The use of industry standard Cat.6, Cat.6a or Cat.7 cable is highly recommended.



5. FEATURES

- HDMI, DisplayPort, and VGA input support
- Input resolution support up to 4K@60Hz (4:4:4, 8-bit) via HDMI and DisplayPort
- HDBaseT feature support: High-Definition (HD) Video and Audio, 100BaseT Ethernet, 48V PoH, and Bi-directional IR pass-through
- Receiver's scaled output supports resolutions up to 4K@60Hz (4:4:4, 8-bit) via HDMI
- Support pass-through of LPCM 2.0/5.1/7.1, Bitstream & HD Bitstream audio formats
- External analog stereo audio embedding/de-embedding support
- Support for automatic input detection and automatic switching on source loss
- Supports controlling a wide variety of conference room equipment such as media players, projectors, projection screens, curtains, etc. via Ethernet, RS-232, IR, or relay (method is device dependent)
- Support for IR code learning as well as IR broadcasting
- Supports Telnet for both client and server functionality
- Control system supports defining up to 16 devices to simplify control and management of controlled devices within the system
- Integrated macro command lists support activating multiple events from a single button press (up to 16 actions per macro)
- Battery backed up RTC (Real Time Clock) to control scheduled macro execution and program event activation
- Supports extended keypad (trigger) control for easy, single button, macro activation (optional equipment)
- Compatible with the wall plate control system, allowing for full control of devices within the same Ethernet network (optional equipment)
- Advanced EDID management options including Internal, External, and User configurations
- Easy firmware updates in the field via USB thumb drive or WebGUI
- Controllable via top-panel buttons (with OSD), WebGUI, Telnet, and RS-232

6. OPERATION CONTROLS AND FUNCTIONS

6.1 Transmitter's Top Panel

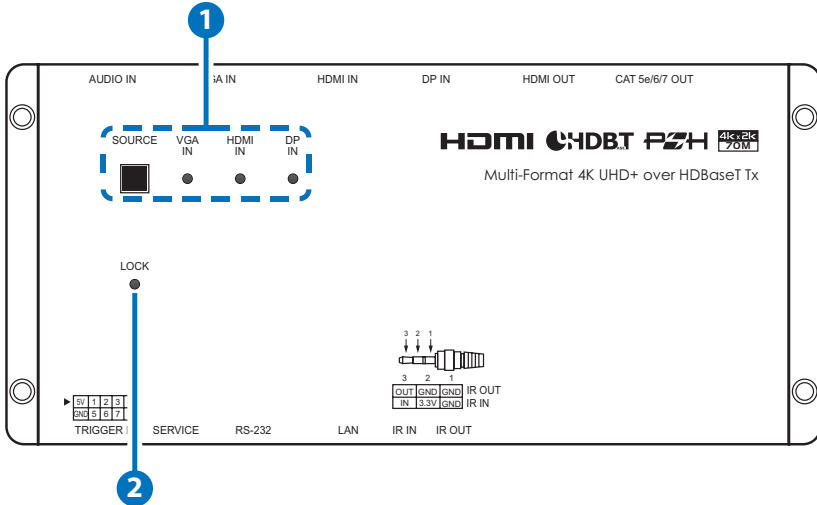

- 1 SOURCE & LEDs:** Press this button to sequentially switch through the available inputs. The LED will illuminate GREEN to indicate which source is currently selected. Live, but unselected, sources will be lit RED.

This unit supports a total of 4 sources (3 on the Tx, 1 on the Rx). The selection sequence is: Tx VGA→Tx HDMI→Tx DP→Rx HDMI→Tx VGA→Etc. When the Rx's HDMI input is selected, the Tx's local mirrored HDMI output will continue to display the last local input that was selected.

- 2 LOCK LED:** This LED will be lit when the unit's controls are in the locked state.

6.2 Transmitter's Front and Rear Panels

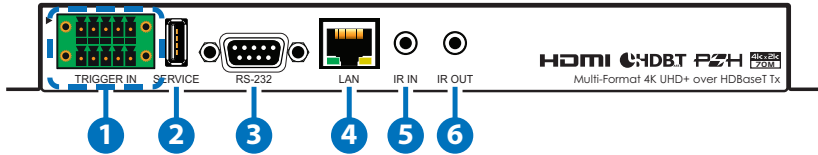

- 1 **TRIGGER IN:** This 10 pin terminal block provides 8 trigger pins for activating functions and macros within the unit. 5V and ground pins are also provided for compatibility and use with the optional Trigger Keypad unit.
- 2 **SERVICE:** This slot is reserved for firmware update use only.
- 3 **RS-232:** Connect to a PC, laptop or other serial control device to send RS-232 commands to control the unit.
- 4 **LAN:** Connect directly, or through a network switch, to your PC/ laptop to control the unit via Telnet/WebGUI and to extend the network across the HDBaseT connection.
- 5 **IR IN:** Connect to the provided IR Extender to extend the IR control range of remotely located devices. Ensure that the remote being used is within direct line-of-sight of the IR Extender.
- 6 **IR OUT:** Connect to the provided IR Blaster to transmit IR signals to devices within direct line-of-sight of the IR Blaster.

Note: The IR In/Out ports are multi-function and may be reconfigured as IR Control, IR Emitter, and IR Learner in addition to the basic IR Bypass functionality.

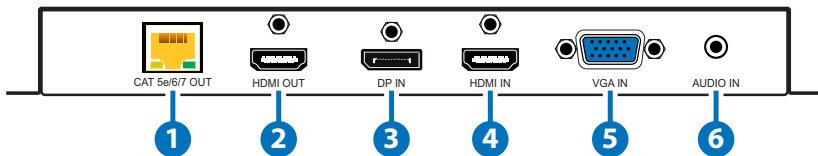

- 1 **CAT5e/6/7 OUT:** Connect to a compatible HDBaseT Receiver with a single Cat.5e/6/7 cable for transmission of all data signals.
- 2 **HDMI OUT:** Connect to HDMI TVs, monitors or amplifiers for digital video and audio output.

Note: This HDMI output is bypass only and is independent from the

timing/color space transmitted over the HDBaseT output.

- 3 DP IN:** Connect to DisplayPort source equipment such as a PC or laptop.
- 4 HDMI IN:** Connect to HDMI source equipment such as a media player, game console or set-top box.
- 5 VGA IN:** Connect to VGA source equipment such as a PC or laptop.
- 6 AUDIO IN:** Connect to the stereo analog output of a device such as a CD player or PC.

6.3 Receiver's Top Panel

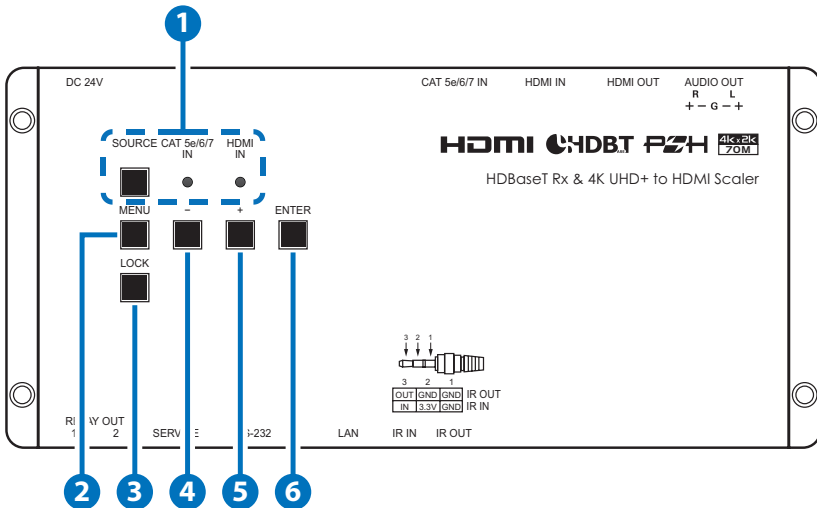

- 1 SOURCE & LEDs:** Press this button to sequentially switch through the available inputs. The LED will illuminate GREEN to indicate the selected source is currently live. When the selected source has no signal it will be lit RED.

When connected to the compatible switching HDBaseT Tx this unit supports a total of 4 sources (3 on the Tx, 1 on the Rx). The selection sequence is: Tx VGA→Tx HDMI→Tx DP→Rx HDMI→Tx VGA→Etc. When the Rx's HDMI input is selected, the Tx's local mirrored HDMI output will continue to display the last local input that was



selected.

- 2 MENU:** Press to enter the OSD menu, or to back out from menu items.

Note: Pressing "MENU" and "+" together will reset the output resolution to XGA (1024×768@60Hz). Pressing "Menu" and "-" together will reset the output resolution to 720p@60Hz.

- 3 LOCK:** Press and hold for 3 seconds to lock all button functions on the top panel of both the Tx and Rx. Press and hold for 3 seconds to release the lock function. The LED will be lit when the top panel is in the locked state.

- 4 - (MINUS/DOWN):** Press to move down or adjust selections within OSD menus.

- 5 + (PLUS/UP):** Press to move up or adjust selections within OSD menus.

Note: Pressing and holding "-" or "+" will accelerate the scrolling or parameter adjustment speed.

- 6 ENTER:** Press to confirm a selection within the OSD or to go deeper into a menu item.

6.4 Receiver's Front and Rear Panels

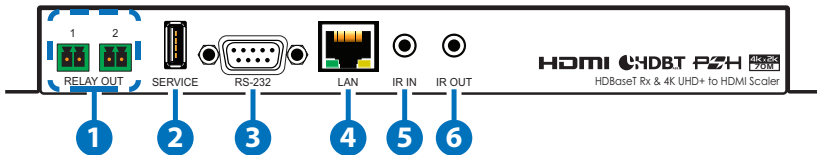

- 1 RELAY OUT 1~2:** Connect to devices that support relay triggered power activation, such as projector screens or blinds, to control them via macro commands.

Note: The voltage/amp limit for these relay connections is 0 ~ 30VDC/10A or 0 ~ 250VAC/10A.

- 2 SERVICE:** This slot is reserved for firmware update use only.
- 3 RS-232:** Connect to a Projector, Media Player or other serial controllable device to directly control RS-232 devices using the unit's scheduling and macro functions.

Note: The operational mode of the RS-232 port (Control/Console)

can be changed in the OSD menu to allow RS-232 control of the Receiver rather than control of remote devices.

- 4 **LAN:** Connect directly, or through a network switch, to your PC/ laptop to control the unit via Telnet/WebGUI and to extend the network across the HDBaseT connection.

Note: Control is only available when connected to a compatible collaboration HDBaseT Transmitter.

- 5 **IR IN:** Connect to the provided IR Extender to extend the IR control range of remotely located devices. Ensure that the remote being used is within direct line-of-sight of the IR Extender.

- 6 **IR OUT:** Connect to the provided IR Blaster to transmit IR signals to devices within direct line-of-sight of the IR Blaster.

Note: The IR In/Out ports are multi-function and may be reconfigured as IR Control, IR Emitter, and IR Learner in addition to the basic IR Bypass functionality.

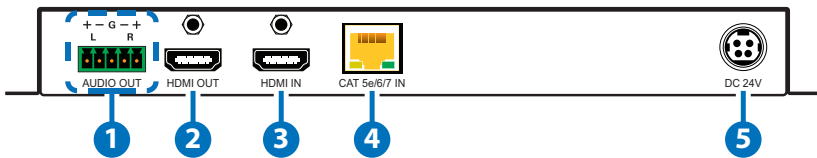

- 1 **AUDIO OUT:** Connect to powered speakers or an amplifier for stereo analog audio output (balanced or unbalanced).
- 2 **HDMI OUT:** Connect to HDMI TVs, monitors or amplifiers for digital video and audio output.
- 3 **HDMI IN:** Connect to HDMI source equipment such as a media player, game console or set-top box.
- 4 **CAT5e/6/7 IN:** Connect to a compatible HDBaseT Transmitter with a single Cat.5e/6/7 cable for transmission of all data signals.
- 5 **DC 24V:** Plug the 24V DC power adapter into this port and connect it to an AC wall outlet for power.



6.5 OSD Menu

LEVEL 1	LEVEL 2	LEVEL 3
Output Resolution	800×600@60	
	1024×768@60	
	1280×768@60	
	1360×768@60	
	1280×800@60	
	1440×900@60	
	1280×1024@60	
	1400×1050@60	
	1680×1050@60	
	1600×1200@60	
	1920×1200@60 RB	
	720×480p@60	
	720×576p@50	
	1280×720p@50	
	1280×720p@60	
	1920×1080i@50	
	1920×1080p@50	
	1920×1080i@60	
	1920×1080p@60	
	3840×2160p@24	
	3840×2160p@25	
	3840×2160p@30	
	3840×2160p@50 Y420	
	3840×2160p@60 Y420	
	3840×2160p@50	
	3840×2160p@60	
Bypass		

LEVEL 1	LEVEL 2	LEVEL 3
Output Color Format	Format	Auto
		HDMI
		DVI
	Color Space	Auto
		YUV422
		YUV444
		RGB
		Bypass
	Color Depth	Auto
		16bit
		12bit
		10bit
		8bit
		Bypass
	Output Image Adjust	Brightness
Contrast		0 ~ 100 (66)
Saturation		0 ~ 100 (70)
Hue		0 ~ 100 (50)
Sharpness		0 ~ 100 (60)
Aspect Ratio		Full
		Auto
		4:3
		16:10
		16:9
Under Scan		No
	95	
	90	
	85	
	80	
Default	Yes/No	

LEVEL 1	LEVEL 2	LEVEL 3
Output Audio Control	HDMI Audio	Unmute
		Mute
	Ext Audio	Unmute
		Mute
	Ext Volume	0 ~ 100 (80)
	Input	Informational Display
L/R Clock		
Channel Num		
HDMI Information	Notify	5Sec Off
		10Sec Off
		15Sec Off
		30Sec Off
		Always
		Never
	Input	Informational Display
	Reso	
	Color	
	Output	Informational Display
Reso		
Color		
EDID Control	HDBT In	Int FHD 2CH
		Int FHD MCH
		Int UHD 2CH
		Int UHD MCH
		Int UHD+ 2CH
		Int UHD+ MCH
		External1/2
		User1/2/3/4

LEVEL 1	LEVEL 2	LEVEL 3
EDID Control	HDMI In	Int FHD 2CH
		Int FHD MCH
		Int UHD 2CH
		Int UHD MCH
		Int UHD+ 2CH
		Int UHD+ MCH
		External 1/2
		User1/2/3/4
	Vendor	Informational Display
	Name	
	MaxReso	
	MaxBaWth	
	MaxDepth	
HDR Fmt		
YCbCr		
HDCP Control	HDBT In	Apple Mode
		Refer Source
		Refer Display
	HDMI In	Apple Mode
		Refer Source
		Refer Display
	In Capable	Informational Display
	Out Capable	
	In Active	
	Out Active	
Relay Control	Relay Out1	On/ Off
	Relay Out2	On/ Off

LEVEL 1	LEVEL 2	LEVEL 3
RS232 Control	Local Console	On/ Off
		Baud Rate
		2400
		4800
		7200
		9600
		14400
		19200
		38400
		57600
		115200
	Data Length	5bit
		6bit
		7bit
		8bit
	Parity	None
Odd		
Even		
Stop Bit	1bit	
	2bit	
OSD Setting	Auto Off	5Sec
		10Sec
		15Sec
		30Sec
		60Sec
		Never
	Horizontal	0 ~ 100 (2)
	Vertical	0 ~ 100 (3)
	Transparency	0 ~ 7 (3)

LEVEL 1	LEVEL 2	LEVEL 3
OSD Setting	Panel Size	Auto
		Normal
		Large
	Panel Color	Gray
		Red
		Green
		Blue
	Font Color	Blue
		Black
		White
		Yellow
		Cyan
	FreeRun Color	Black
Red		
Green		
Blue		
Default	Yes/No	
System Setting	VID	Informational Display
	PID	
	SN	
	FW Version	
	FW Update	Yes/No
	Factory Reset	Yes/No
Ethernet Information	Mac	Informational Display
	Mode	
	IP	
	Mask	
	GWay	

Notes:

- The OSD only provides controls for the collaboration Receiver's functions. To control the functions of both the collaboration Transmitter and Receiver, please use the WebGUI or Telnet.
- Items in Bold are factory default settings. The individual functions will be introduced in the following paragraphs.

▶ **Output Resolution**

Due to the possibility of selecting an output resolution or format that is not supported by the connected display, after selecting a new resolution the OSD will display a confirmation screen. If "YES" is not selected on the confirmation screen within 12 seconds, the output resolution will change back to the previous setting.

When the output resolution is set to "Bypass", the scaler in the Receiver will be disabled and the "Output Image Adjust" menu will be disabled and greyed out. However, the "Output Color Format" menu's options can still be adjusted.

▶ **Output Color Format**

Format: If "Auto" is selected, and the sink's EDID does not correspond to the CEA-861 specifications, this will be set to HDMI.

Color Space: The "YUV 4:2:0" color space can only be selected when the output resolution is 4K@50Hz or 4K@60Hz. When the Format is "DVI", the color space selection will be grayed out and automatically set to "RGB".

Color Depth: When the Format is "DVI" or the color space is "YUV 4:2:2", the Color Depth section will be grayed out and automatically set to "8-bit".

▶ **HDMI Information**

Notify: When the input state changes, the OSD will automatically display the currently detected input resolution for the selected period of time.

When connected to a collaboration Transmitter the OSD Info function will be replaced by the Transmitter's OSD Banner and controlled via the WebGUI's settings.

▶ **EDID Control**

Input EDID: When connected to a collaboration Transmitter, the "HDBT Input EDID" section will be grayed out because the

Transmitter's EDID is controlled via the WebGUI. This option is only available when connected to a "basic" HDBaseT Tx.

Due to the limited OSD display space, the following have been abbreviated: Y44 = YUV 4:4:4, Y42 = YUV 4:2:2, Y40 = YUV 4:2:0.

▶ **HDCP Control**

When connected to a collaboration Transmitter the "HDBT Input HDCP" section will be grayed out because it is not needed.

Due to the limited OSD display space, the following have been abbreviated: H1.4 = HDCP 1.4, H2.2 = HDCP 2.2.

▶ **Ethernet Information**

Only available when connected to a collaboration Transmitter.

6.6 IR Cable Pin Assignments

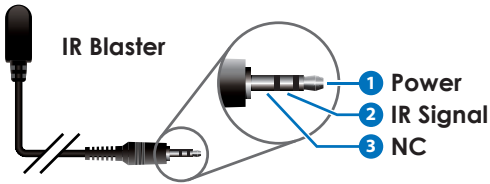
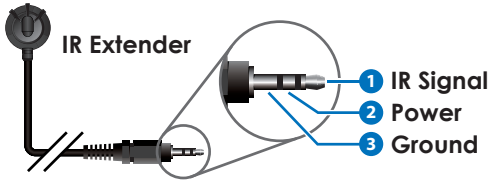

6.7 RS-232 Protocol

UNIT			REMOTE SYSTEM	
Pin	Definition		Pin	Definition
1	NC		1	NC
2	TxD		2	RxD
3	RxD	▶	3	TxD
4	NC	◀	4	NC
5	GND		5	GND
6	NC		6	NC
7	NC		7	NC
8	NC		8	NC
9	NC		9	NC

Baud Rate: 115200bps

Data Bits: 8

Parity Bits: None

Stop Bit: 1

Flow Control: None

6.8 Telnet Control

6.8.1 Telnet Access

Before attempting to use Telnet control, please ensure that both the unit and the PC/Laptop are connected to the same active networks.

To access Telnet	
In Windows 7	Click Start , type "cmd" in the search field, and press Enter .
In Windows XP	Click Start > Run , type "cmd", and press Enter .
In Mac OS X	Click Go > Applications > Utilities > Terminal .

Once in the CLI (Command Line Interface) type "telnet" followed by the IP address of the unit and "23", then hit "Enter".

```
Microsoft Windows [Version 6.1.7601]
Copyright (c) 2009 Microsoft Corporation. All rights reserved.

C:\Users\Administrator>telnet 192.168.1.50 23
```

This will connect us to the unit we wish to control. Type "\$help" to list the available commands.

Note: The IP address of the unit can be found in the OSD within the "Ethernet" menu item.

6.8.2 Telnet/RS-232 Commands

- **Important Notes**

- These Telnet/RS-232 commands are received and processed by the collaboration Transmitter, however, some commands are only available when a collaboration Receiver is also connected to the Transmitter. The section containing these special case commands has been marked with (**).
- Certain parameter values of normal commands, marked with a (*), require the connection of a collaboration Receiver to be valid. For example, Input 4 is only available as valid option when a collaboration Receiver is connected, but Inputs 1~3 are always available.
- Commands will not be executed unless followed by a carriage return (marked with a ↵ in the command list). Commands are not case-sensitive.
- If the IP address is changed then the IP address required for Telnet access will also change accordingly.

1. System Commands

COMMAND	DESCRIPTION AND PARAMETERS
HELP ↵	Show the full command list.
HELP N1 ↵	Show help details about command N1. N1 = {Any command name}
? ↵	Show the full command list.
? N1 ↵	Show help details about command N1. N1 = {Any command name}
GET FW VER ↵	Show the unit's current firmware version.
GET MODEL NAME ↵	Show the unit's model name.
SET DESCRIPTION N1 ↵	Set the system's description text. N1 = {Description string}
GET DESCRIPTION ↵	Display the system description.
SET KEYLOCK N1 ↵	Set the front panel lock state for the unit. Available values for N1: OFF [Unlock Keypad] ON [Lock Keypad]
GET KEYLOCK ↵	Show the current front panel lock state.
SET SYSTEM REBOOT ↵	Force the system to reboot.
SET FACTORY DEFAULT ↵	Reset all settings to the factory default.
SET BANNER DEFAULT ↵	Reset the output banner to the default.
SET ETHERNET DEFAULT ↵	Reset Ethernet settings to the default.
SET REMOTE DEFAULT ↵	Reset all remote settings to their defaults.

2. Input Commands

COMMAND	DESCRIPTION AND PARAMETERS
GET IN PORT NUMBER↵	Show the system input port number.
GET IN TYPE LIST↵	Show the system input's type.
SET IN N1 EDID N2↵	Assign EDID N2 to input N1. N1 = 1 ~ 4 [Input number]* Available values for N2: 1 [Internal FHD 2CH] 2 [Internal FHD MCH] 3 [Internal UHD 2CH] 4 [Internal UHD MCH] 5 [Internal UHD+ 2CH] 6 [Internal UHD+ MCH] 7 [User 1] 8 [User 2] 9 [User 3] 10 [User 4] 11 [HDMI Output] 12 [HDBaseT Output]
GET IN N1 EDID↵	Display input N1's EDID source. N1 = 1 ~ 4 [Input number]*
SET IN N1 HDCP MODE N2↵	Set input N1's HDCP mode. N1 = 1 ~ 4 [Input number]* Available values for N2: 0 [HDCP Off] 1 [Refer to Source] 2 [Refer to Display]
GET IN N1 HDCP MODE↵	Show input N1's HDCP mode. N1 = 1 ~ 4 [Input number]*
GET IN N1 HDCP STATUS↵	Show input N1's current HDCP status. N1 = 1 ~ 4 [Input number]*
GET IN N1 FORMAT↵	Show input N1's current format. N1 = 1 ~ 4 [Input number]* <i>Note: Only the currently active input can be read.</i>

2. Input Commands

COMMAND	DESCRIPTION AND PARAMETERS
GET IN N1 COLOR SPACE↵	Show input N1's current color space. N1 = 1 ~ 4 [Input number]* <i>Note: Only the currently active input can be read.</i>
GET IN N1 COLOR DEPTH↵	Show input N1's current color depth. N1 = 1 ~ 4 [Input number]* <i>Note: Only the currently active input can be read.</i>
GET IN N1 TIMING↵	Show input N1's current resolution/ timing. N1 = 1 ~ 4 [Input number]* <i>Note: Only the currently active input can be read. Input 4's state is not available.</i>
GET IN N1 AUDIO↵	Show input N1's current audio state. N1 = 1 ~ 3 [Input number] <i>Note: Only the currently active input can be read. Input 4's state is not available.</i>
SET IN N1 NAME N2↵	Set the name of input N1. N1 = 1 ~ 4 [Input number]* N2 = {Name} [Input name]
GET IN N1 NAME↵	Show input N1's name. N1 = 1 ~ 4 [Input number]*
GET IN N1 EDID DATA↵	List input N1's current EDID data in ASCII HEX. N1 = 1 ~ 4 [Input number]*
GET IN N1 EDID INFORMATION↵	Show input N1's current EDID information. N1 = 1 ~ 4 [Input number]*

3. Output Commands

COMMAND	DESCRIPTION AND PARAMETERS
GET OUT PORT NUMBER↵	Show the number of available output ports in the system.
GET OUT TYPE LIST↵	List the system's output types.
SET OUT ROUTE N1↵	Switch the output routing source to input N1. N1 = 1 ~ 4 [Input number]* <i>Note: Both outputs will display the same source except when Input 4 is selected. Input 4 can only display on Output B on the collaboration Rx.</i>
SET OUT ROUTE NEXT↵	Switch the output routing source to the next sequential input. <i>Note: Both outputs will display the same source except when Input 4 is selected. Input 4 can only display on Output B on the collaboration Rx.</i>
GET OUT ROUTE↵	Show the output's current routing source.
SET OUT N1 AUDIO SOURCE N2↵	Set the output audio source. N1 = A ~ B [Output letter] Available values for N2: 1 [Follow Video] 2 [Use L/R Input]
GET OUT N1 AUDIO SOURCE↵	Display the output audio source setting. N1 = A ~ B [Output letter]
SET OUT N1 AUDIO MUTE N2↵	Mute or unmute the audio of output N1. N1 = A ~ B [Output letter] Available values for N2: OFF [Unmute] ON [Mute]

3. Output Commands

COMMAND	DESCRIPTION AND PARAMETERS
GET OUT N1 AUDIO MUTE↵	Show output N1's audio mute setting. N1 = A ~ B [Output letter]
SET OUT AUTO AUDIO N1↵	Set the output's audio auto detection. Available values for N1: OFF [No auto-select] ON [Auto-select]
GET OUT AUTO AUDIO↵	Show the current auto audio mode state.
GET OUT N1 HDCP STATUS↵	Show output N1's current HDCP status. N1 = A ~ B [Output letter]
GET OUT N1 HPD↵	Show output N1's current hot plug detection state. N1 = A ~ B [Output letter]
GET OUT N1 RSENSE↵	Show output N1's current RSENSE status. N1 = A ~ B [Output letter]
SET OUT AUTO SWITCH N1↵	Enable or disable automatic source switching. Available values for N1: OFF [Auto switch disabled] ON [Auto switch enabled] <i>Note: Both outputs will display the same source except when Input 4 is selected. Input 4 can only display on Output B on the collaboration Rx.</i>
GET OUT AUTO SWITCH↵	Show the current auto switch mode state.

3. Output Commands

COMMAND	DESCRIPTION AND PARAMETERS
SET OUT N1 MASK B↵	<p>Enable or disable mask setting on output N1</p> <p>N1 = A ~ B [Output letter]</p> <p>Available values for N1:</p> <p>OFF [Mask disabled]</p> <p>ON [Mask enabled]</p> <p><i>Note: When an output is masked, all video, including the banner, will be blanked out.</i></p>
GET OUT N1 MASK↵	<p>Display the output mask setting.</p> <p>N1 = A ~ B [Output letter]</p>
SET OUT N1 NAME N2↵	<p>Set the name for output N1.</p> <p>N1 = A ~ B [Output letter]</p> <p>N2 = {Name} [Input name]</p>
GET OUT N1 NAME↵	<p>Show output N1's name.</p> <p>N1 = A ~ B [Output letter]</p>
GET OUT N1 EDID DATA↵	<p>List output N1's current EDID data in ASCII HEX.</p> <p>N1 = A ~ B [Output letter]</p>
GET OUT N1 EDID INFORMATION↵	<p>Show output N1's current EDID information.</p> <p>N1 = A ~ B [Output letter]</p>

4. Control System Commands

COMMAND	DESCRIPTION AND PARAMETERS
Event	
SET EVENT N1 NAME N2↵	Set the name for Event N1. N1 = 1 ~ 64 [Event number] N2 = {Name} [Event name]
GET EVENT N1 NAME↵	Show the name of Event N1. N1 = 1 ~ 64 [Event number]
SET EVENT N1 N2↵	Enable or disable Event N1. N1 = 1 ~ 64 [Event number] Available values for N2: OFF [Event disabled] ON [Event enabled]
GET EVENT N1↵	Show the enabled state for Event N1. N1 = 1 ~ 64 [Event number]
SET EVENT N1 TYPE N2↵	Set Event N1 to event type N2. N1 = 1 ~ 64 [Event number] Available values for N2: 1 [Input] 2 [Output] 3 [System Command] 4 [COM Port] 5 [Telnet] 6 [IR] 7 [Ext Trigger] 8 [RTC (Clock)]
GET EVENT N1 TYPE↵	Show the event type of Event N1. N1 = 1 ~ 64 [Event number]
GET EVENT N1 PARAMETER↵	Show the parameters of Event N1 (parameters displayed depend on the Event type). N1 = 1 ~ 64 [Event number]

4. Control System Commands

COMMAND	DESCRIPTION AND PARAMETERS
GET EVENT N1 CONDITION↵	Show Event N1's activation condition (conditions displayed depend on the Event type). N1 = 1 ~ 64 [Event number]
SET EVENT N1 MODE N2↵	Set Event N1 to use activation mode N2. N1 = 1 ~ 64 [Event number] Available values for N2: 1 [Once] 2 [Single Mode] 3 [Repeat Mode] 4 [Toggle Mode]
GET EVENT N1 MODE↵	Show Event N1's activation mode. N1 = 1 ~ 64 [Event number]
SET EVENT N1 MACRO N2↵	Assign macro N2 to Event N1. N1 = 1 ~ 64 [Event number] N2 = 1 ~ 64 [Macro number]
GET EVENT N1 MACRO↵	Show the macro currently assigned to Event N1. N1 = 1 ~ 64 [Event number]
SET EVENT N1 TOGGLE MACRO N2↵	Assign the secondary macro to use when Event N1 is set to toggle mode. N1 = 1 ~ 64 [Event number] N2 = 1 ~ 64 [Macro number]
GET EVENT N1 TOGGLE MACRO↵	Show Event N1's secondary macro when in toggle mode. N1 = 1 ~ 64 [Event number]
SET EVENT N1 TIMER N2↵	Set Event N1's hold timer duration to N2 seconds. N1 = 1 ~ 64 [Event number] N2 = 0 ~ 65535 [Seconds] <i>Note: Not used in all Event modes.</i>

4. Control System Commands

COMMAND	DESCRIPTION AND PARAMETERS
GET EVENT N1 TIMER↵	Show Event N1's hold timer duration. N1 = 1 ~ 64 [Event number]
SET EVENT N1 DELAY N2↵	Set Event N1's delay value to N2 seconds. N1 = 1 ~ 64 [Event number] N2 = 0 ~ 65535 [Seconds]
GET EVENT N1 DELAY↵	Show Event N1's delay. N1 = 1 ~ 64 [Event number]
SET EVENT N1 REPEAT N2↵	Set the number of repetitions to use when Event N1 is in repeat mode. N1 = 1 ~ 64 [Event number] N2 = 0 ~ 255 [Repeat count]
GET EVENT N1 REPEAT↵	Show Event N1's repeat count when in repeat mode. N1 = 1 ~ 64 [Event number]
GET EVENT N1 BOOK↵	Show the detailed description of Event N1's actions. N1 = 1 ~ 64 [Event number]
SET EVENT N1 DELETE↵	Delete Event N1. N1 = 1 ~ 64 [Event number]
Macro	
SET MACRO N1 NAME N2↵	Set the name for macro N1. N1 = 1 ~ 64 [Macro number] N2 = {Name} [Macro name]
GET MACRO N1 NAME↵	Show macro N1's name. N1 = 1 ~ 64 [Macro number]

4. Control System Commands

COMMAND	DESCRIPTION AND PARAMETERS
SET MACRO N1 ACTION N2 CMDPOOL N3↵	<p>Assign command N3 to action N2 of macro N1.</p> <p>N1 = 1 ~ 64 [Macro number] N2 = 1 ~ 16 [Action number] N3 = 1 ~ 128 [Command number]</p>
GET MACRO N1 ACTION N2 CMDPOOL↵	<p>Show the command pool index number of the command assigned to action N2 of macro N1.</p> <p>N1 = 1 ~ 64 [Macro number] N2 = 1 ~ 16 [Action number]</p>
SET MACRO N1 ACTION N2 DELAY N3↵	<p>Set a delay of N3 to action N2 of macro N1.</p> <p>N1 = 1 ~ 64 [Macro number] N2 = 1 ~ 16 [Action number] N3 = 1 ~ 65535 [Milliseconds]</p>
GET MACRO N1 ACTION N2 DELAY↵	<p>Show the delay for action N2 of macro N1.</p> <p>N1 = 1 ~ 64 [Macro number] N2 = 1 ~ 16 [Action number]</p>
SET MACRO N1 ACTION N2 INTERFACE N3↵	<p>Set the command interface for action N2 of macro N1.</p> <p>N1 = 1 ~ 64 [Macro number] N2 = 1 ~ 16 [Action number]</p> <p>Available values for N3:</p> <p>1 [System command] 2 [COM Port] 3 [Telnet] 4 [IR] 5 [Relay] 6 [Banner] 7 [Use Device List]</p>

4. Control System Commands

COMMAND	DESCRIPTION AND PARAMETERS
GET MACRO N1 ACTION N2 INTERFACE↵	Show the command interface for action N2 of macro N1. N1 = 1 ~ 64 [Macro number] N2 = 1 ~ 16 [Action number]
GET MACRO N1 ACTION N2 PARAMETER↵	Show the interface parameters of action N2 in macro N1. N1 = 1 ~ 64 [Macro number] N2 = 1 ~ 16 [Action number]
SET MACRO N1 ACTION N2 DEVICE N3↵	Set the device to use for action N2 of macro N1 when the interface type is set to Device. N1 = 1 ~ 64 [Macro number] N2 = 1 ~ 16 [Action number] N3 = 1 ~ 16 [Device number]
GET MACRO N1 ACTION N2 DEVICE↵	Show the device used by action N2 of macro N1 when the interface type is set to Device. N1 = 1 ~ 64 [Macro number] N2 = 1 ~ 16 [Action number]
SET MACRO N1 DELETE↵	Delete macro N1. N1 = 1 ~ 64 [Macro number]
SET MACRO N1 ACTION N2 DELETE↵	Delete action N2 of macro N1. N1 = 1 ~ 64 [Macro number] N2 = 1 ~ 16 [Action number]
SET MACRO N1 RUN↵	Run macro N1 immediately. N1 = 1 ~ 64 [Macro number]
SET MACRO N1 ABORT↵	Abort the execution of macro N1. N1 = 1 ~ 64 [Macro number]
SET MACRO N1 PAUSE↵	Pause macro N1's execution. N1 = 1 ~ 64 [Macro number]

4. Control System Commands

COMMAND	DESCRIPTION AND PARAMETERS
SET MACRO N1 RESUME↵	Resume the execution of paused macro N1. N1 = 1 ~ 64 [Macro number]
Command Pool	
SET CMDPOOL N1 NAME N2↵	Set the name for command N1 in the command pool. N1 = 1 ~ 128 [Command number] N2 = {Name} [Command name]
GET CMDPOOL N1 NAME↵	Show the name of command N1 in the command pool. N1 = 1 ~ 128 [Command number]
SET CMDPOOL N1 DATA N2↵	Set the text data contents of command N1. N1 = 1 ~ 128 [Command number] N2 = {Text} [Command data] <i>Note: Commands can contain a maximum of 256 characters.</i>
GET CMDPOOL N1 DATA↵	Show the text data contents of command N1. N1 = 1 ~ 128 [Command number]
SET CMDPOOL N1 ENDCHAR N2↵	Set the termination character to send after command N1. N1 = 1 ~ 128 [Command number] Available values for N2: 0 [Null] 1 [CR] 2 [LF] 3 [CR+LF] 4 [SP] 5 [STX] 6 [ETX]

4. Control System Commands

COMMAND	DESCRIPTION AND PARAMETERS
GET CMDPOOL N1 ENDCHAR↵	Show the termination character selected for command N1. N1 = 1 ~ 128 [Command number]
SET CMDPOOL N1 DELETE↵	Delete command N1 from the command pool. N1 = 1 ~ 128 [Command number]
Device	
SET CTLDEVICE N1 NAME N2↵	Set the name for device N1. N1 = 1 ~ 16 [Device number] N2 = {Name} [Device name]
GET CTLDEVICE N1 NAME↵	Show the name for device N1. N1 = 1 ~ 16 [Device number]
SET CTLDEVICE N1 INTERFACE N2↵	Set the interface for device N1. N1 = 1 ~ 16 [Device number] Available values for N2: 1 [COM Port (On Tx)] 2 [Telnet (On Tx)] 3 [IR (On Tx)] 129 [COM Port (On Rx)] 130 [Telnet (On Rx)] 131 [IR (On Rx)] 132 [Relay (On Rx)]
GET CTLDEVICE N1 INTERFACE↵	Show the interface used by device N1. N1 = 1 ~ 16 [Device number]
GET CTLDEVICE N1 PARAMETER↵	Show the parameters of the interface used by device N1. N1 = 1 ~ 16 [Device number]
SET CTLDEVICE N1 DELETE↵	Delete device N1. N1 = 1 ~ 16 [Device number]

5. Real Time Clock Commands

COMMAND	DESCRIPTION AND PARAMETERS
SET YEAR N1↵	Set the real time clock year to N1. N1 = 2017 ~ 2116 [Year]
GET YEAR↵	Show the real time clock year.
SET MONTH N1↵	Set the real time clock month to N1. N1 = 1 ~ 12 [Month]
GET MONTH↵	Show the real time clock month.
SET DAY N1↵	Set the real time clock day to N1. N1 = 1 ~ 31 [Day]
GET DAY↵	Show the real time clock day.
SET WEEK N1↵	Set the real time clock day of the week to N1. Available values for N1: 1 [Sunday] 2 [Monday] 3 [Tuesday] 4 [Wednesday] 5 [Thursday] 6 [Friday] 7 [Saturday]
GET WEEK↵	Show the real time clock day of the week.
SET HOUR N1↵	Set the real time clock hour to N1. N1 = 0 ~ 23 [Hour (24-hour format)]
GET HOUR↵	Show the real time clock hour.
SET MINUTE N1↵	Set the real time clock minute to N1. N1 = 0 ~ 59 [Minute]
GET MINUTE↵	Show the real time clock minute.
SET SECOND N1↵	Set the real time clock second to N1. N1 = 0 ~ 59 [Second]
GET SECOND↵	Show the real time clock second.

5. Real Time Clock Commands

COMMAND	DESCRIPTION AND PARAMETERS
SET DATE YYYY.MM.DD↵	Set the real time clock's year, month and day with a single command. YYYY = 2017 ~ 2116 [Year] MM = 1 ~ 12 [Month] DD = 1 ~ 31 [Day]
GET DATE↵	Show the real time clock's date in YYYY.MM.DD format.
SET TIME HH:MM:SS↵	Set the real time clock's hour, minute and second with a single command. HH = 0 ~ 23 [Hour (24-hour format)] MM = 0 ~ 59 [Minute] SS = 0 ~ 59 [Second]
GET TIME↵	Show the real time clock's time in HH:MM:SS format.
SET MERIDIEM N1↵	Set the real time clock to display in the banner using the 12-hour clock or 24-hour clock format. Available values for N1: OFF [24-hour clock] ON [12-hour clock]
GET MERIDIEM↵	Show the real time clock meridiem setting.
SET CALENDAR FORMAT N1↵	Set the real time clock banner display format. Available values for N1: 1 [yyyy-mm-dd hh:mm] 2 [mm-dd-yyyy hh:mm] 3 [dd-mm-yyyy hh:mm] 4 [M-dd-W hh:mm] 5 [dd-M-W hh:mm]

5. Real Time Clock Commands

COMMAND	DESCRIPTION AND PARAMETERS
GET CALENDAR FORMAT↵	Show the real time clock banner display format.
SET TIMESYNC N1↵	Set the method of setting the unit's time. Available values for N1: OFF [Manual set] ON [Web browser time sync]
GET TIMESYNC↵	Show the current time sync setting.

6. Banner Commands

COMMAND	DESCRIPTION AND PARAMETERS
SET OUT N1 BANNER N2↵↵	<p>Enable or disable Output N1's banner.</p> <p>N1 = A ~ B [Output letter]</p> <p>Available values for N2:</p> <p>OFF [Banner disabled]</p> <p>ON [Banner enabled]</p>
GET OUT N1 BANNER↵	<p>Show Output N1's banner enable state.</p> <p>N1 = A ~ B [Output letter]</p>
SET OUT N1 BANNER MODE N2↵↵	<p>Set the banner text display mode.</p> <p>N1 = A ~ B [Output letter]</p> <p>Available values for N2:</p> <p>1 [Show Input timing & time]</p> <p>2 [Show user text]</p>
GET OUT N1 BANNER MODE↵	<p>Show the banner text display mode.</p> <p>N1 = A ~ B [Output letter]</p>
SET OUT N1 BANNER TEXT N2↵↵	<p>Set the user banner text string.</p> <p>N1 = A ~ B [Output letter]</p> <p>N2 = {Text} [Banner text (64 char max)]</p>
GET OUT N1 BANNER TEXT↵	<p>Show the current user banner text for Output N1.</p> <p>N1 = A ~ B [Output letter]</p>

6. Banner Commands

COMMAND	DESCRIPTION AND PARAMETERS
SET OUT N1 BANNER FONT COLOR N2↵	<p>Set Output N1's banner text color.</p> <p>N1 = A ~ B [Output letter]</p> <p>Available values for N2:</p> <p>1 [Black]</p> <p>2 [White]</p> <p>3 [Red]</p> <p>4 [Green]</p> <p>5 [Blue]</p> <p>6 [Yellow]</p> <p>7 [Cyan]</p> <p>8 [Magenta]</p> <p>9 [Gray]</p>
GET OUT N1 BANNER FONT COLOR↵	<p>Show Output N1's banner text color.</p> <p>N1 = A ~ B [Output letter]</p>
SET OUT N1 BANNER BACKGROUND COLOR N2↵	<p>Set Output N1's banner background color.</p> <p>N1 = A ~ B [Output letter]</p> <p>Available values for N2:</p> <p>1 [Red]</p> <p>2 [Green]</p> <p>3 [Blue]</p> <p>4 [Gray]</p>
GET OUT N1 BANNER BACKGROUND COLOR↵	<p>Show Output N1's banner background color.</p> <p>N1 = A ~ B [Output letter]</p>

6. Banner Commands

COMMAND	DESCRIPTION AND PARAMETERS
SET OUT N1 BANNER TRANSPARENCY N2↵	<p>Set Output N1's banner transparency level.</p> <p>N1 = A ~ B [Output letter]</p> <p>Available values for N2:</p> <p>1 [Level 1 (opaque)]</p> <p>2 [Level 2]</p> <p>3 [Level 3]</p> <p>4 [Level 4]</p> <p>5 [Level 5]</p> <p>6 [Level 6]</p> <p>7 [Level 7]</p> <p>8 [Level 8 (transparent)]</p>
GET OUT N1 BANNER TRANSPARENCY↵	<p>Show Output N1's banner transparency level.</p> <p>N1 = A ~ B [Output letter]</p>
SET OUT N1 BANNER TIMEOUT N2↵	<p>Set Output N1's banner timeout in seconds.</p> <p>N1 = A ~ B [Output letter]</p> <p>Available values for N2:</p> <p>0 [No timeout]</p> <p>1 ~ 1000 [Timeout in seconds]</p>
GET OUT N1 BANNER TIMEOUT↵	<p>Show Output N1's banner timeout in seconds.</p> <p>N1 = A ~ B [Output letter]</p>

7. IR Commands

COMMAND	DESCRIPTION AND PARAMETERS
SET IR N1 LEARN N2↵	<p>Initiate the IR learning function on IR Input N1. The captured IR code will be written to command slot N2.</p> <p>Available values for N1:</p> <p>1 [IR input on Tx] 2 [IR input on Rx]</p> <p>N2 = 1 ~ 128 [Command number]</p> <p><i>Notes: The capture function will timeout automatically after 15 seconds if no signal is received. The command index must already have a valid name assigned to it to store IR data.</i></p>
SET IR N1 EMIT N2↵	<p>Emit the IR code stored in command N2 over IR Output N1.</p> <p>Available values for N1:</p> <p>A [IR output on Tx] B [IR output on Rx]</p> <p>N2 = 1 ~ 128 [Command number]</p>

8. Collaboration Receiver Commands**

COMMAND	DESCRIPTION AND PARAMETERS
Output	
SET OUT N1 TIMING N2↵	<p>Set the output timing for Rx Output N1.</p> <p>N1 = B [HDMI Out on the Rx]</p> <p>Available values for N2:</p> <p>0 [Bypass]</p> <p>1 [800×600@60]</p> <p>2 [1024×768@60]</p> <p>3 [1280×768@60]</p> <p>4 [1360×768@60]</p> <p>5 [1280×800@60]</p> <p>6 [1440×900@60]</p> <p>7 [1280×1024@60]</p> <p>8 [1400×1050@60]</p> <p>9 [1680×1050@60]</p> <p>10 [1600×1200@60]</p> <p>11 [1920×1200@60 (RB)]</p> <p>12 [720×480p@60]</p> <p>13 [720×576p@60]</p> <p>14 [1280×720p@50]</p> <p>15 [1280×720p@60]</p> <p>16 [1920×1080i@50]</p> <p>17 [1920×1080p@50]</p> <p>18 [1920×1080i@60]</p> <p>19 [1920×1080p@60]</p> <p>20 [3840×2160p@24]</p> <p>21 [3840×2160p@25]</p> <p>22 [3840×2160p@30]</p> <p>23 [3840×2160p@50 (YUV 4:2:0)]</p> <p>24 [3840×2160p@60 (YUV 4:2:0)]</p> <p>25 [3840×2160p@50]</p> <p>26 [3840×2160p@60]</p>

8. Collaboration Receiver Commands**

COMMAND	DESCRIPTION AND PARAMETERS
GET OUT N1 TIMING↵	Show the current output timing for Rx Output N1. N1 = B [HDMI Out on the Rx]
SET OUT N1 COLOR SPACE N2↵	Set Rx Output N1's color space. N1 = B [HDMI Out on the Rx] Available values for N2: 0 [Bypass] 1 [RGB] 2 [YUV 4:4:4] 3 [YUV 4:2:2] 4 [YUV 4:2:0] 5 [Auto Detect] <i>Note: Selecting the 4:2:2 or 4:2:0 color space might result in incorrect colors if the connected display does not support the combination of color space and output timing.</i>
GET OUT N1 COLOR SPACE↵	Show Rx Output N1's color space. N1 = B [HDMI Out on the Rx]
SET OUT N1 COLOR DEPTH N2↵	Set Rx Output N1's color bit depth. N1 = B [HDMI Out on the Rx] Available values for N2: 0 [Bypass] 1 [8bit] 2 [10bit] 3 [12bit] 4 [16-bit] 5 [Auto Detect] <i>Note: Outputting YUV 4:2:2 at bit depths above 8-bit might result in incorrect color.</i>
GET OUT N1 COLOR DEPTH↵	Show Rx Output N1's color bit depth. N1 = B [HDMI Out on the Rx]

8. Collaboration Receiver Commands**

COMMAND	DESCRIPTION AND PARAMETERS
SET OUT N1 FORMAT N2↵	Set Rx Output N1's video format. N1 = B [HDMI Out on the Rx] Available values for N2: 1 [DVI Mode] 2 [HDMI Mode] 3 [Auto Detect]
GET OUT N1 FORMAT↵	Show Rx Output N1's video format. N1 = B [HDMI Out on the Rx]
SET OUT N1 BRIGHTNESS N2↵	Set Rx Output N1's brightness. N1 = B [HDMI Out on the Rx] N2 = 0 ~ 100 [Brightness level] <i>Note: Only active when the output timing is not set to "Bypass".</i>
GET OUT N1 BRIGHTNESS↵	Show Rx Output N1's brightness. N1 = B [HDMI Out on the Rx]
SET OUT N1 CONTRAST N2↵	Set Rx Output N1's contrast. N1 = B [HDMI Out on the Rx] N2 = 0 ~ 100 [Contrast level] <i>Note: Only active when the output timing is not set to "Bypass".</i>
GET OUT N1 CONTRAST↵	Show Rx Output N1's contrast. N1 = B [HDMI Out on the Rx]
SET OUT N1 SATURATION N2↵	Set Rx Output N1's saturation. N1 = B [HDMI Out on the Rx] N2 = 0 ~ 100 [Saturation level] <i>Note: Only active when the output timing is not set to "Bypass".</i>
GET OUT N1 SATURATION↵	Show Rx Output N1's saturation. N1 = B [HDMI Out on the Rx]

8. Collaboration Receiver Commands**

COMMAND	DESCRIPTION AND PARAMETERS
SET OUT N1 HUE N2↵	Set Rx Output N1's hue. N1 = B [HDMI Out on the Rx] N2 = 0 ~ 100 [Hue level] <i>Note: Only active when the output timing is not set to "Bypass".</i>
GET OUT N1 HUE↵	Show Rx Output N1's hue. N1 = B [HDMI Out on the Rx]
SET OUT N1 SHARPNESS N2↵	Set Rx Output N1's sharpness. N1 = B [HDMI Out on the Rx] N2 = 0 ~ 100 [Sharpness level] <i>Note: Only active when the output timing is not set to "Bypass".</i>
GET OUT N1 SHARPNESS↵	Show Rx Output N1's sharpness. N1 = B [HDMI Out on the Rx]
SET OUT N1 ASPECT RATIO N2↵	Set Rx Output N1's aspect ratio. N1 = B [HDMI Out on the Rx] Available values for N2: 1 [Full Screen] 2 [16:9] 3 [16:10] 4 [4:3] 5 [Maintain source aspect] <i>Note: Only active when the output timing is not set to "Bypass".</i>
GET OUT N1 ASPECT RATIO↵	Show Rx Output N1's aspect ratio. N1 = B [HDMI Out on the Rx]

8. Collaboration Receiver Commands**

COMMAND	DESCRIPTION AND PARAMETERS
Audio	
SET AUDIO OUT MUTE N1↵	Mute or un-mute the Rx's external stereo analog audio output. Available values for N1: OFF [Un-mute] ON [Mute] <i>Note: The stereo analog audio output will always be muted with bitstream audio sources.</i>
GET AUDIO OUT MUTE↵	Show the mute state of the Rx's external stereo analog audio output.
SET AUDIO OUT VOLUME N1↵	Set the volume level of the Rx's external stereo analog audio output. N1 = 0 ~ 100 [Volume level]
SET AUDIO OUT VOLUME UP↵	Increase the volume level of the Rx's external stereo analog audio output by 1.
SET AUDIO OUT VOLUME DOWN↵	Decrease the volume level of the Rx's external stereo analog audio output by 1.
GET AUDIO OUT VOLUME↵	Show the volume level of the Rx's external stereo analog audio output.
Relay	
SET RELAY N1 N2↵	Set relay N1 on the Receiver to open or closed. N1 = 1 ~ 2 [Relay number] Available values for N2: OFF [Relay open] ON [Relay closed]
GET RELAY N1↵	Show relay N1's current state. N1 = 1 ~ 2 [Relay number]

9. User EDID Commands

COMMAND	DESCRIPTION AND PARAMETERS
GET USER EDID NUMBER ↵	List the number of User EDID slots.
GET USER N1 EDID DATA ↵	Show the ASCII HEX data from User EDID N1. N1 = 1 ~ 4 [User EDID number]
GET USER N1 EDID INFORMATION ↵	Show basic spec information from User EDID N1. N1 = 1 ~ 4 [User EDID number]

10. Ethernet Commands

COMMAND	DESCRIPTION AND PARAMETERS
SET IP ADDR N1 ↵	Set the static IP Address. N1 = X.X.X.X [X = 0 ~ 255]
GET IP ADDR ↵	Show the current IP address.
SET NETMASK N1 ↵	Set the netmask address. N1 = X.X.X.X [X = 0 ~ 255]
GET NETMASK ↵	Show the current netmask.
SET GATEWAY N1 ↵	Set the gateway address. N1 = X.X.X.X [X = 0 ~ 255]
GET GATEWAY ↵	Show the current gateway.
SET IP MODE N1 ↵	Set the IP address assignment mode. Available values for N1: 1 [Static IP mode] 2 [DHCP mode]
GET IP MODE ↵	Show the current IP mode.
SET HTTP PORT N1 ↵	Set the HTTP port for WebGUI access. N1 = 0 ~ 65535 [Port number]
GET HTTP PORT ↵	Show the current HTTP port.
SET TELNET PORT N1 ↵	Set the Telnet port. N1 = 0 ~ 65535 [Port number]
GET TELNET PORT ↵	Display the device's Telnet port.

6.9 WebGUI Control

6.9.1 Device Discovery APP

- Please obtain the Device Discovery software from your authorized dealer and save it in a directory where you can easily find it.
- Connect the unit and your PC/laptop to the same active network and execute the Device Discovery software.
- Click on “Search” and a list of devices connected to the local network will show up indicating their current IP address.

Help

#	Interface	Product	Description	IP Address	MAC Addr
1	ETHERNET	MFP Extender	MULTI format Presentation Extender	192.168.1.50	

- By clicking on one of the listed devices you will be presented with the network details of that particular device.

IP Configure | EDID Console | EDID Creator | System

Select

Information

Product ID : MFP Extender

Product Name : MFP Extender

MAC Address : FF:FF:FF:FF:FF:FF

IP Mode : **Static IP**

IP Address : 192.168.1.50

SubNet Mask : 255.255.255.0

Gateway IP : 192.168.1.254

DNS : 0.0.0.0

WebGUI Port : 80

Telnet Port : 0

S / N : SN:

Description :

- **IP Mode:** If you choose, you can alter the static IP network settings for the device, or switch the unit into DHCP mode to automatically obtain proper network settings from a local DHCP server. To switch to DHCP mode, please select DHCP from the IP mode drop-down, then click “Save” (📁).
- **WebGUI:** Once you are satisfied with the network settings, you may use them to connect via Telnet or WebGUI. The network information window provides a convenient link to launch the WebGUI directly by clicking the “Home Page” icon (🏠). It will automatically open your default browser to the main web page.

6.9.2 WebGUI Control Page

After connecting to the WebGUI's address in a web browser, the login screen will appear. Please enter the appropriate user name and password then click "Submit" to log in.

Note: The default user name and password is "admin".

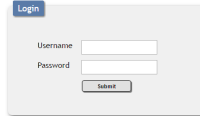

On the left side of the browser you will see the following menu tabs where all primary functions of the paired collaboration Transmitter and Receiver are controllable via the built in WebGUI: A/V Switch, EDID, Banner, Collaboration, Event Book, Event, Macro, Command, Device, Network, and System. The individual functions will be introduced in the following sections.

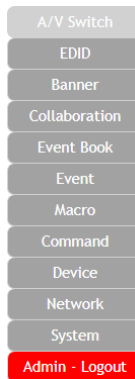

1. Audio/Video Switch

This tab provides A/V routing control, A/V mute controls, and I/O renaming options.

To assign a new video or audio route, please click the button of the Output you wish to send video/audio to on the left and then click on the button of the preferred Input port (video or audio) on the right. As you select each button they will change their color to orange. The new route will become active immediately and the routing information displayed on the buttons will change accordingly.

Note: Normally both outputs will be mirrored, however if Output B's source is switched to HDMI 2 then Output A will not switch and will continue to show the previously selected source.

Audio/Video Switch

Output

HDMI

Name: Output A User Name. ✎

A Video: Input 2 User Name. Mask: OFF

Audio: Replaced from Ext L/R Mute: OFF

Timing: 3840x2160p@59Hz

HDBaseT

Name: Output B User Name. ✎

B Video: Input 2 User Name. Mask: OFF

Audio: Follow Video Mute: OFF

Timing: 1920x1080p@60Hz

Input

Video Group Auto: OFF

VGA Name: Input 1 User Name. ✎

Link: No

HDMI Name: Input 2 User Name. ✎

Link: Yes

DP Name: Input 3 User Name. ✎

Link: Yes

HDMI2 Name: Input 4 User Name. ✎

Link: Yes

Audio Group Auto: OFF

Follow Video

Replaced from Ext L/R

48

- **Output HDMI/HDBaseT**

- **A/B:** Buttons for selecting the Output (A or B) to route video or audio sources to.
- **Name:** Displays the name for the Output. Click the  icon to edit the Output's name.
- **Video:** Displays the Input that is currently routed to the Output.
- **Audio:** Displays the audio embedding mode for the Output.
- **Timing:** Displays the current output resolution and timing for the Output.
- **Mask:** Click the switch to enable/disable the Output's video mask function (Off = normal video, On = black screen with sync).
- **Mute:** Click the switch to enable/disable the Output's audio mute function.

- **Input Video Group**

- **VGA/HDMI/DP/HDMI2:** Buttons for selecting the video Input to route to the selected Output.
- **Name:** Displays the name for the Input. Click the  icon to edit the Input's name.
- **Link:** Displays the Input's source signal detection state.
- **Auto:** Click the switch to enable/disable auto source switching functionality.

- **Input Audio Group**

- **Follow Video/Replaced from Ext L/R:** Buttons for selecting the audio to embed with the video being routed to the selected Output. When auto audio routing is enabled, manual selection is disabled.
- **Auto:** Click the switch to enable/disable auto audio selection functionality.

2. EDID

This collaboration Transmitter provides the option of six internal EDIDs, four customer uploaded EDIDs, and two sink sourced EDIDs that can be assigned to each input port individually. All EDIDs are available for download and saving to a PC. Important details from each EDID may also be displayed.

This tab allows for the assignment of an EDID to each individual input port, or to all inputs at once. Click as many of the Input EDID buttons on the left as desired and then select the preferred EDID from the buttons displayed on the right. The new EDID will become active immediately.

Note: In some rare cases it is possible for user or external EDIDs to cause compatibility issues with certain sources. If this happens, it is recommended to switch to one of the 6 internal EDIDs for maximum compatibility.

EDID

User EDID

USER 1 Upload Download Information

Output EDID

Output A Download Information

Input EDID

1 Input 1 User Name. Download Information

1080p@60/PCM/2CH

2 Input 2 User Name. Download Information

Output A

3 Input 3 User Name. Download Information

Output B

4 Input 4 User Name. Download Information

4K2K@60/PCM/Bit-Stream/MCH

USER 1 EDID Information ✕

Vendor : STD

Name : EXTENDER

Max Resolution : 1080p@60Hz

Max Bandwidth : 0MHz

Color Space : RGB,YUV444,YUV422

Color Depth : 8bit

Audio Format : PCM

HDR Format : No HDR

Edid Table List ✕

Internal	User	External
1080p@60/PCM/2CH	USER 1	Output A
1080p@60/PCM/Bit-Stream/MCH	USER 2	Output B
4K2K@30/PCM/2CH	USER 3	
4K2K@30/PCM/Bit-Stream/MCH	USER 4	
4K2K@60/PCM/2CH		
4K2K@60/PCM/Bit-Stream/MCH		

50

- **User EDID**

- **Drop-down Menu:** Drop-down to select a User EDID for upload, download or to view its information details.
- **Upload:** Click to upload a previously saved EDID file (*.bin) from the PC to the selected User EDID slot.
- **Download:** Click to download the selected EDID file (*.bin) to the PC.
- **Information:** Click to show additional information about the selected EDID.

- **Output EDID**

- **Drop-down Menu:** Drop-down to select the EDID read from a connected Output for download or to view its information details.
- **Download:** Click to download the selected EDID file (*.bin) to the PC.
- **Information:** Click to show additional information about the selected EDID.

- **Input EDID**

- **Input EDID 1~4:** Click to select one or more Inputs to open the EDID Table List for assigning an EDID.
- **Download:** Click to download the current Input's EDID file (*.bin) to the PC.
- **Information:** Click to show additional information about the Input's current EDID.

- **EDID Information**

- Displays the most recently requested EDID information details.
- Click the  icon to close the EDID Information window.

- **EDID Table List**

- Click one of the available EDIDs to assign to the selected Inputs.
- Click the  icon to close the EDID Table List window.

3. Banner

This tab provides control over the content, format and activation of the OSD banner information displayed on both outputs.



Click the Enable switch to enable/disable the corresponding OSD banner. Click the  icon to open the corresponding Banner Edit page.

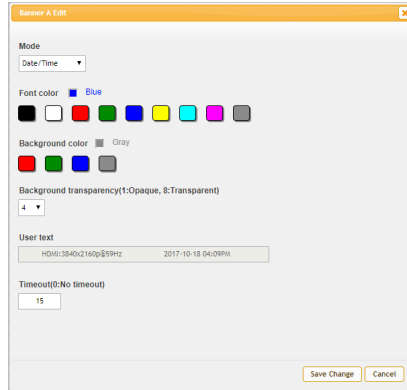

- **Mode:** Select the OSD banner display text content.
- **Font Color:** Select the OSD banner font color.
- **Background Color:** Select the OSD banner background color.
- **Background Transparency:** Select the OSD banner background transparency level. The range is from 1 (opaque) to 8 (transparent).
- **User Text:** Enter customized banner text (only available when "User Text" mode is selected).
- **Timeout:** Set the OSD banner timeout (in seconds).

4. Collaboration

This tab provides controls for the Output B scaler and other features implemented within the collaboration Receiver including output resolution, audio volume, proc-amp functions, and relay control.

Note: If a non-collaboration Receiver is connected, functions on this tab will be disabled.

The screenshot shows a web interface for the Collaboration tab. It is organized into several sections:

- Information:** Shows 'Linked: Yes', 'Mode Name: MFP Receiver', 'FW Version: v1.0A', and 'Serial Number:'.
- Firmware Upgrade:** Includes a 'Choose File' button, the text 'No file chosen', and an 'Upgrade' button.
- Relay:** Features two toggle switches for 'Port 1' and 'Port 2', both currently set to 'OFF'.
- Resolution:** Includes a 'Timing' dropdown menu set to '1920x1080p@60' and an 'Aspect Ratio' dropdown menu set to 'Keep input ratio'.
- Audio:** Contains a 'Mute' toggle switch set to 'OFF' and a 'Volume' slider set to 80.
- Scaler:** Features five sliders for 'Brightness: 30', 'Contrast: 60', 'Saturation: 50', 'Hue: 50', and 'Sharpness: 50'. A 'Scaler Reset' button is located below these sliders.



- **Information**

Displays the HDBaseT link state, operational mode, Receiver firmware version and serial number.

- **Relay**

Click to open (OFF) or close (ON) the relays located on the Receiver.

- **Resolution**

Dropdown menus allowing for the selection of the output resolution, and aspect ratio behavior, of the Receiver's HDMI output. Selections are enacted immediately.

- **Audio**

Provides control over the analog audio output on the Receiver. Click the Mute switch to enable or disable analog audio output. Move the Volume slider to control the analog output volume.

Note: Digital audio output via HDMI cannot be adjusted.

- **Firmware Upgrade**

Provides a way to update the Receiver's firmware. Click "Choose File" to select the firmware update file from the local PC (*.bin format). After selecting an appropriate file, click the "Upgrade" button to begin the update process.

- **Scaler**

This section provides slider controls for brightness, contrast, saturation, hue, and sharpness allowing adjustment to the HDMI output on the Receiver. Clicking the "Scaler Reset" button will restore all of these scaler settings back to the factory default.

5. Event Book

The Event Book tab provides a way to view the details of all existing Events, both active and inactive, that are saved in the unit. The conditions to activate an Event and the actions that are performed once the event has been triggered are listed in an easy to read natural English format.

Note: The Event Book is read only.

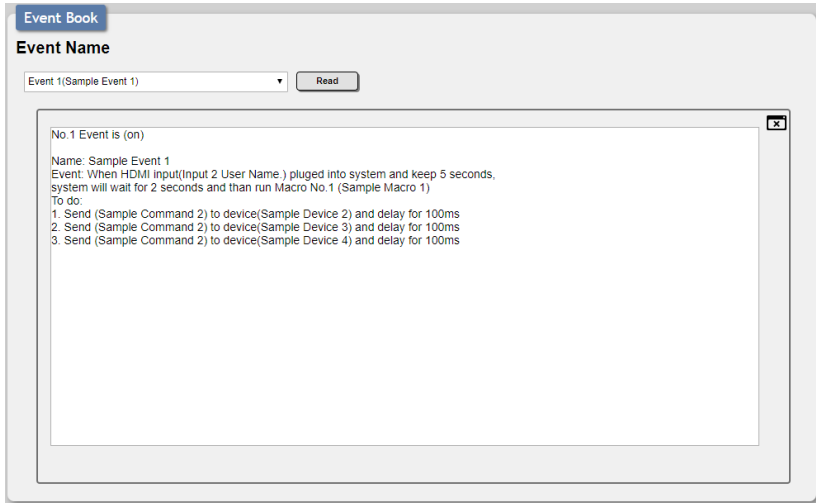

Click the drop-down to select the Event name and then click "Read" to display the event description.

6. Event

The Event tab allows the creation, editing and deletion of Events. An "Event" is the core process of the entire control system and determines when and how macros are activated. Each Event can be individually named (up to 32 characters) and contains an Event Type, Event Condition, Event Mode, and the Macro(s) to be run. This unit supports 8 different Event sources.

To create a new Event, click the "New" button on a blank Event line. By default, new events are set as inactive. To set the Event as active, click the On/Off switch, next to the Event name, so that it reads "ON". To edit an existing Event, click the "Edit" button. To delete an existing Event, click the "Delete" button.

Note: Before creating new Events, please be sure that all required macros, commands and devices have already been defined.

Event								
No.	Active	Event Name	Event Type	Event Condition	Mode	Macro	Edit	Delete
1	<input checked="" type="checkbox"/>	Sample Event 1	Input-Local HDMI	Plug In	Single	Sample Macro 1	Edit	Delete
2	<input type="checkbox"/>	Sample Event 2	Serial Port-Remote,Buad Rate:19200,Data Length:8,Parity Bit:none,Stop Bit:1	Sample Command 1	Once	Sample Macro 1	Edit	Delete
3	<input type="checkbox"/>	Sample Event 3	TCP/IP IP:192.168.1.50,Port:23	Sample Command 1	Single	Sample Macro 3	Edit	Delete
4	<input checked="" type="checkbox"/>	Sample Event 4	IR Receiver-Local Input	Sample Command 1	Once	Sample Macro 2	Edit	Delete
5	<input checked="" type="checkbox"/>	Sample Event 5	Output-A	Plug Change	Single	Sample Macro 1	Edit	Delete
6	<input type="checkbox"/>	Sample Event 6	System Command	Sample Command 2	Repeat	Sample Macro 3	Edit	Delete
7	<input checked="" type="checkbox"/>	Sample Event 7	External Trigger 5	Both Edge	Toggle	Sample Macro 2,Sample Macro 3	Edit	Delete
8	<input checked="" type="checkbox"/>	Sample Event 8	Schedule-Mon. Tue. Wed. Thu. Fri. 11:30:26		Single	Sample Macro 1	Edit	Delete
9	<input type="checkbox"/>						New	Delete
10	<input type="checkbox"/>						New	Delete
11	<input type="checkbox"/>						New	Delete
12	<input type="checkbox"/>						New	Delete

- **Active:** Displays the active state of each Event. Events that have Active set to "OFF" cannot be triggered.
- **Event Name:** Displays each Event's name.
- **Event Type:** Displays the type of trigger/interface that is being watched to activate an Event. Event types include: Input, Output, System Command, Serial Port, TCP/IP, IR Receiver, External Trigger, and Schedule.
- **Event Condition:** Displays the condition, if applicable for the selected Event Type, required to trigger the Event. Examples of conditions are: Low, High, Falling, Raising, Both Edge, or a Command.

- **Event Mode:** Displays the currently selected behavior for the Event. Events can have one of the following mode types.
 - **Once:** The Event's macro is run one time when triggered and then will not be activated again. If the unit is rebooted, all "Once" Events will become active again.
 - **Single:** The Event's macro is run a single time each time the Event is triggered.
 - **Repeat:** The Event's macro is repeatedly run a pre-determined number of times (up to 255) each time the Event is triggered. A delay time between each repeat can be set.
 - **Toggle:** The Event runs alternating macros (a single time for each trigger) each time the Event is triggered.
- **Macro:** Displays the name of the macro to run when the Event is triggered.
- **Edit/New:** Click the "Edit" or "New" button to open the Event Edit window and edit an existing Event, or create a new one. When creating a new Event, as each field is completed, additional fields will appear as parameters are filled in, as appropriate to the Event type and selections made. Once the Event is completely defined, click "Save" to store the Event.

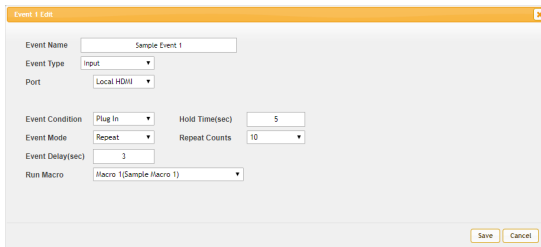

- **Delete:** Click to delete an Event.

7. Macro

The “Macro” tab provides a way to create, edit, run and delete macros. Up to 64 macros can be stored in the unit, and each macro can contain up to 16 individual actions with user defined delays (in milliseconds) between each command’s execution. Macros can be executed by Events, or they can be executed directly via the WebGUI or Telnet.

Click on the “Edit” or “New” button to open the macro editing window. At the top of the macro edit window is a text field where you can set the name of the macro. Type your new macro name into the box and then click the  icon to save it.

Note: The Macro tab is not available when the user is logged in using an “Operator” level account.

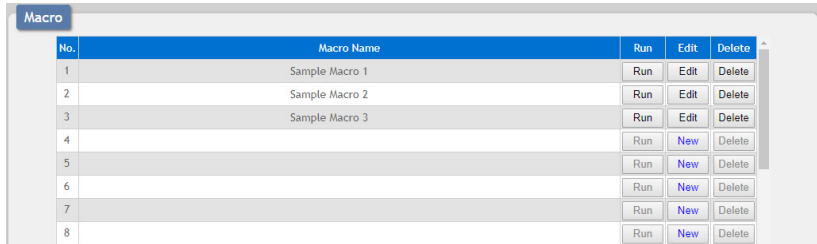

No.	Macro Name	Run	Edit	Delete
1	Sample Macro 1	Run	Edit	Delete
2	Sample Macro 2	Run	Edit	Delete
3	Sample Macro 3	Run	Edit	Delete
4		Run	New	Delete
5		Run	New	Delete
6		Run	New	Delete
7		Run	New	Delete
8		Run	New	Delete

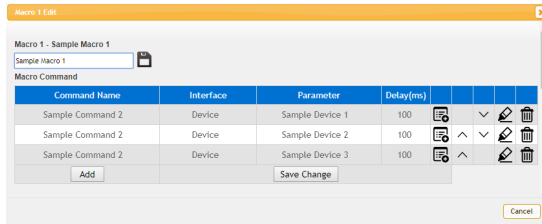

- **Macro Name:** Displays each macro's name.
- **Run:** Click the “Run” button to execute the macro.
- **Edit/New:** Click the “Edit” or “New” button to open the Macro Edit window.
- **Delete:** Click to delete a macro.

• Macro Edit Window



Click the “Add” button to add a new macro action.

- **Command Name:** Displays the name of the command used in each action step of the macro.
- **Interface:** Displays the interface that the command data will be transmitted on.
- **Parameter:** Displays the parameters, if any, required by the selected interface.
- **Delay (ms):** Displays the length of time (in milliseconds) to pause before executing the next action line in the macro.

Click the  icon to only save the macro's name. Click the  icon to open the Edit Command Interface window for the specified macro action. The setting fields displayed will be appropriate for the interface selected. Click the  icon to delete the specified macro action.

Click the “Up Arrow” to move the command up one position in the execution sequence. Click the “Down Arrow” to move the command down one position in the execution sequence. Click the “Save Change” button to save all changes to the current macro.

• Interface Edit Window

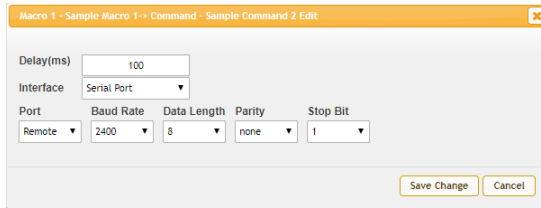

The “Delay(ms)” setting is the length of time to wait before sending the next action and is set in milliseconds. Click on “Save Change” to confirm the settings.

Note: It is strongly suggested to not set a delay time less than 100ms for system commands or less than 500ms for Telnet/Serial commands to ensure that the command is properly received and executed before the next command is sent.

There are 7 possible interface types to send a command to to:

- **System Command:** Sends a command to the unit itself.
Note: See the RS-232/Telnet command list in this manual for a list of valid commands.
- **Serial Port:** Sends the command via one of the serial ports (Remote or Local) at the defined baud rate.
- **TCP/IP:** Sends the command to the specified IP address using the specified port.
- **IR Emitter:** Sends the command via the specified IR emitter port (Remote or Local).
- **Relay:** Controls the specified relay port. The only valid command strings for this interface type are “ON” (or “CLOSE”), and “OFF” (or “OPEN”).
- **Banner:** Sends the command's text to be displayed on the specified OSD banner.
Note: The Delay set for this action determines how long the message stays on screen in the banner. To permanently change the banner text, use a System Command.
- **Device:** Uses an interface that has been pre-defined, including all parameters, in the Device tab.

8. Command

Click on the “Command” tab to create, edit or delete commands. Up to 128 individual commands can be stored in the command pool.

Note: The Command tab is not available when the user is logged in using an “Operator” level account.

No.	Command Name	Command Data	End Char	Edit	Delete
1	Sample Command 1	Sample data to send or receive V1	CR	Edit	Delete
2	Sample Command 2	Sample data to send or receive V2	CR/LF	Edit	Delete
3	Sample Command 3	Sample data to send or receive V3	LF	Edit	Delete
4	Sample Command 4	Sample data to send or receive V4	NONE	Edit	Delete
5				New	Delete
6				New	Delete
7				New	Delete
8				New	Delete

- **Command Name:** Displays the command's name.
- **Command Data:** Displays the command's data.
- **End Char:** Displays the termination character(s) sent after the command.
- **Edit/New:** Click the “Edit” or “New” button to open the Command Edit window where the name, data and end characters can be set or edited. Command names can contain up to 32 characters. Command data can contain up to 256 characters (including spaces). Click on “Save Change” to store the Command.

Command 1 Edit
✕

Command Name

Command Data

IR Learner

End character

- **Delete:** Click this to delete a command.

9. Device

Click on the “Device” tab to add/remove common, or multiple-use device interfaces to make setting up macros which repeatedly use the same interfaces much easier. There are 4 types of device interfaces (either Remote or Local) that can be defined for easy use with a total of 16 stored. The name of each device can be up to 32 characters long (spaces are not allowed). Each defined device is directly linked to any macro commands that they have already been used in, so editing them will immediately change the behavior of the macros they are being used in.

Note: The Device tab is not available when the user is logged in using an “Operator” level account.

Device					
No.	Device Name	Interface	Configuration	Edit	Delete
1	Sample Device 1	Remote:Serial Port	Baud Rate:19200,Data Length:8,Parity:none,Stop Bit:1	Edit	Delete
2	Sample Device 2	Local:TCP/IP	IP:192.168.1.50,Port:23	Edit	Delete
3	Sample Device 3	Remote:IR Emitter	Port:A	Edit	Delete
4	Sample Device 4	Local:IR Emitter	Port:A	Edit	Delete
5				New	Delete
6				New	Delete
7				New	Delete
8				New	Delete

- **Device Name:** Displays the device's name.
- **Interface:** Displays the device's selected interface type.
- **Configuration:** Displays the configuration settings for the device.
- **Edit/New:** Click the “Edit” or “New” button to open the Device Edit window. The setting fields displayed will be appropriate for the interface selected. Click on the “Save” button to save the device definition.

The image shows a dialog box titled "Device 1 Edit". It contains the following fields and controls:

- Device Name:** A text input field containing "Sample Device 1".
- Interface:** A dropdown menu currently showing "Remote:Serial Port".
- Baud rate:** A dropdown menu showing "19200".
- Data length:** A dropdown menu showing "8".
- Parity:** A dropdown menu showing "none".
- Stop bit:** A dropdown menu showing "1".
- Buttons:** "Save" and "Cancel" buttons at the bottom right.

- **Delete:** Click the “Delete” button to delete the specified device.

10. Network

Click on the "Network" tab to make changes to various network settings. From this tab you can change the WebGUI IP configuration, login account and login timeout settings.

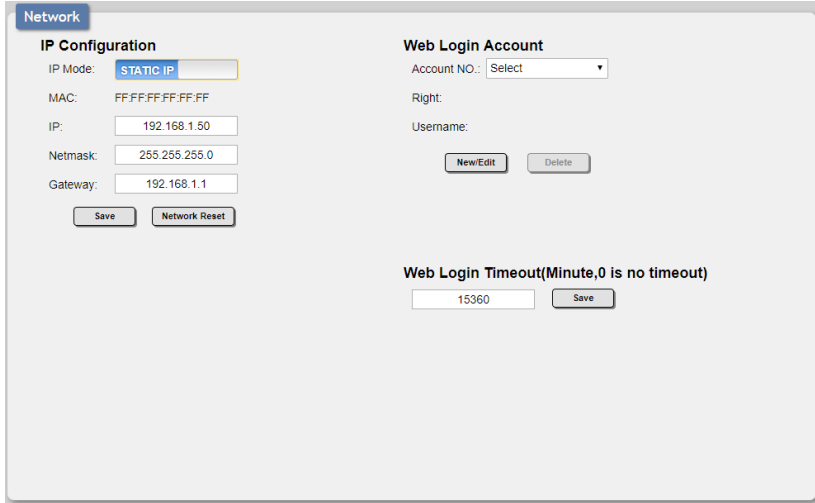

Network

IP Configuration

IP Mode:

MAC:

IP:

Netmask:

Gateway:

Web Login Account

Account NO.:

Right:

Username:

Web Login Timeout(Minute,0 is no timeout)

- **IP Configuration**

This section allows for configuration of the Ethernet settings of the unit. The IP mode may be switched between DHCP or Static IP. When the unit is set to DHCP mode it will attempt to automatically obtain an IP address from a DHCP server. When the IP mode is set to static IP, you can manually set the IP address, netmask and gateway address. Click on the "Save" button to save changes made to the IP Configuration. To reset the unit's IP Configuration to the factory default, press the "Network Reset" button.

Note: The default network setting for this unit is "Static IP" and the default IP address is 192.168.1.50.

- **Web Login Account**

Click the drop-down to select the user account number to edit (out of a total of 4 available users). After selecting an account, click the "New/Edit" button to set or modify the username, password, and access privileges (Administrator or Operator).

Note: The built-in "admin" user can't be modified and the default password is "admin".

Account 1 Edit

Right: (dropdown menu open showing Administrator, Operator)

Username:

Old Password:

New Password:

Confirm Password:

Save Change Cancel

- **Web Login Timeout**

Manually set the length of time before a connected WebGUI user is automatically logged out due to inactivity. Available values range from 0 to 35790 (in minutes). Setting this value to 0 disables the timeout.

11. System

This tab provides access to control a number of system configuration controls including saving and restoring the system configuration, performing a factory reset, rebooting the system, updating the firmware of the collaboration Transmitter, setting the system's time & date, and displaying the unit's serial number.

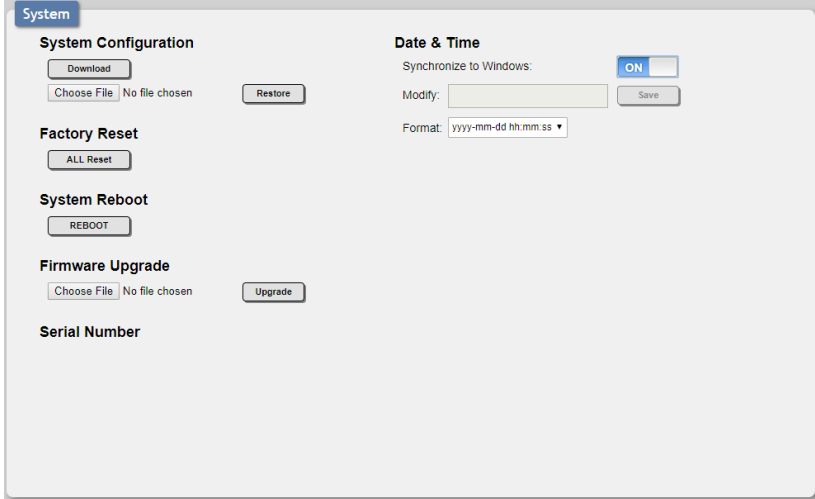

The screenshot shows a web interface for system configuration. It is divided into several sections:

- System Configuration:** Contains a "Download" button, a "Choose File" button (with "No file chosen" text), and a "Restore" button.
- Factory Reset:** Contains an "ALL Reset" button.
- System Reboot:** Contains a "REBOOT" button.
- Firmware Upgrade:** Contains a "Choose File" button (with "No file chosen" text) and an "Upgrade" button.
- Serial Number:** A section header with no visible controls.
- Date & Time:** Contains a "Synchronize to Windows" toggle switch (set to "ON"), a "Modify:" text input field, a "Save" button, and a "Format:" dropdown menu (set to "yyyy-mm-dd hh:mm:ss").

- **System Configuration**

Clicking the "Download" button allows the user to save the full system configuration, including all macros, to a connected PC/Laptop. A previously saved configuration may be re-uploaded to the unit by selecting the file on your local PC/Laptop using the "Choose File" button then clicking the "Restore" button.

- **Factory Reset**

Click the "All Reset" button to reset the unit to factory defaults.

- **System Reboot**

Click the "REBOOT" button to reboot the unit.

- **Firmware Upgrade**

Provides a way to update the Transmitter's firmware. Click "Choose File" to select the firmware update file from the local PC (*.bin format). After selecting an appropriate file, click the "Upgrade" button to begin the update process.

- **Serial Number**

Displays the serial number of the unit.

- **Data & Time**

This allows the user to set the unit's system time which is used by the scheduling function and OSD banner information.

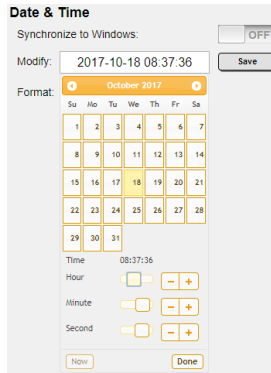

- **Synchronize to Windows:** Selecting "ON" will allow the system to automatically update the time whenever your computer connects to the WebGUI.
- **Modify:** Allows the user to manually set the date & time when the Synchronize to Windows function is set to "OFF". Click the "Modify" field to display the calendar to set the preferred times and date.
- **Format:** Sets the display format for the time and date in the OSD banner.

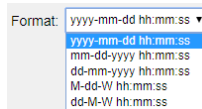

7. CONNECTION DIAGRAM

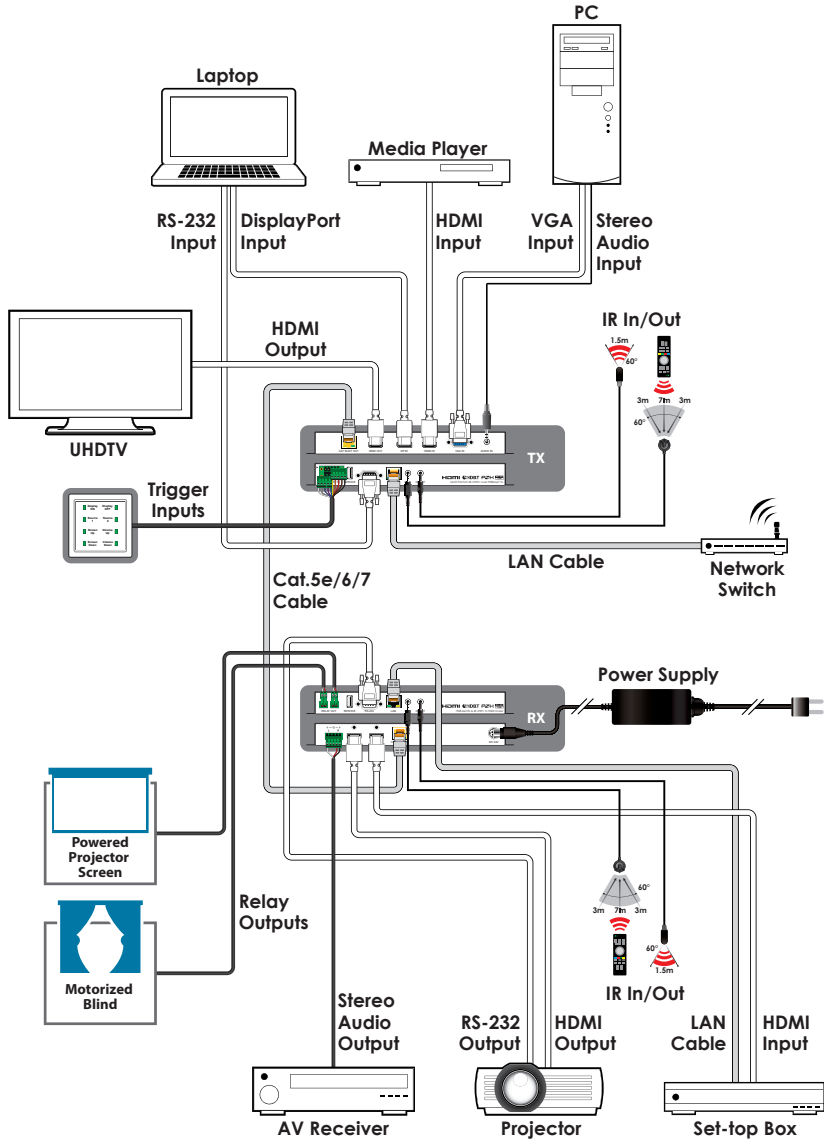



8. SPECIFICATIONS

8.1 Technical Specifications

Transmitter

Video Bandwidth	HDMI: 600MHz/18Gbps HDBaseT: 340MHz/10.2Gbps
Input Ports	1×HDMI 1×DisplayPort 1×VGA 1×3.5mm (Stereo Audio)
Output Ports	1×HDMI 1×Cat.5e/6/7
Control Interfaces	1×IR Blaster (3.5mm) 1×IR Extender (3.5mm) 1×RS-232 (9-pin D-sub) 1×LAN (RJ45) 8×Trigger (Terminal Block)
HDMI Cable Length	10m (1080p@60Hz, 12-bit) 3m (4K@60Hz, 4:4:4, 8-bit)
CAT5e/6 Cable Length	100m (1080p@60Hz, 12-bit) 70m (4K@60Hz, 4:2:0, 8-bit)
IR Frequency	30 - 50kHz (30 - 60kHz under ideal conditions)
Baud Rate	115200bps
Power Supply	48V PoH (Power over HDBaseT)
ESD Protection	Human Body Model: ±8kV (Air Discharge) ±4kV (Contact Discharge)

Dimensions	231.5mm×25mm×108mm (W×H×D) [Case Only] 231.5mm×25mm×120mm (W×H×D) [All Inclusive]
Weight	420g
Chassis Material	Metal
Silkscreen Color	Black
Operating Temperature	0°C - 40°C/32°F - 104°F
Storage Temperature	-20°C - 60°C/-4°F - 140°F
Relative Humidity	20 - 90% RH (Non-condensing)
Power Consumption	12W
Receiver	
Video Bandwidth	HDMI: 600MHz/18Gbps HDBaseT: 340MHz/10.2Gbps
Input Ports	1×HDMI 1×Cat.5e/6/7
Output Ports	1×HDMI 1×Terminal Block (Stereo Audio)
Control Interfaces	1×IR Blaster (3.5mm) 1×IR Extender (3.5mm) 1×RS-232 (9-pin D-sub) 1×LAN (RJ45) 2×Relay (Terminal Block)
HDMI Cable Length	10m (1080p@60Hz, 12-bit) 3m (4K@60Hz, 4:4:4, 8-bit)
CAT5e/6 Cable Length	100m (1080p@60Hz, 12-bit) 70m (4K@60Hz, 4:2:0, 8-bit)
IR Frequency	30 - 50kHz (30 - 60kHz under ideal conditions)
Baud Rate	115200bps



Power Supply	24V/2.7A DC (US/EU standards, CE/FCC/ UL certified)
ESD Protection	Human Body Model: ±8kV (Air Discharge) ±4kV (Contact Discharge)
Dimensions	231.5mm×25mm×108mm (W×H×D) [Case Only] 231.5mm×25mm×120mm (W×H×D) [All Inclusive]
Weight	430g
Chassis Material	Metal
Silkscreen Color	Black
Operating Temperature	0°C - 40°C/32°F - 104°F
Storage Temperature	-20°C - 60°C/-4°F - 140°F
Relative Humidity	20 - 90% RH (Non-condensing)
Power Consumption	24W

8.2 Video Specifications

8.2.1 Transmitter's Resolutions

Transmitter's Supported Resolutions (Hz)	Input			Output	
	VGA	HDMI	DP	HDMI	HDBT
640×480p@60	✓	✓	✓	✓	✓
640×480p@72	✓	✓	✓	✓	✓
640×480p@75	✓	✓	✓	✓	✓
640×480p@85	✓	✓	✓	✓	✓
720×400p@70	✓	✓	✗	✓	✓
720×400p@85	✗	✓	✗	✓	✓
720×480i@59	✗	✓	✗	✓	✓
720×480i@60	✗	✓	✗	✓	✓
720×480p@59	✗	✓	✓	✓	✓
720×480p@60	✗	✓	✓	✓	✓
720×576i@50	✗	✓	✗	✓	✓
720×576p@50	✓	✓	✓	✓	✓
800×600p@56	✓	✓	✓	✓	✓
800×600p@60	✓	✓	✓	✓	✓
800×600p@72	✓	✓	✓	✓	✓
800×600p@75	✓	✓	✓	✓	✓
800×600p@85	✓	✓	✓	✓	✓
848×480p@60	✗	✓	✓	✓	✓
1024×768p@60	✓	✓	✓	✓	✓
1024×768p@70	✓	✓	✓	✓	✓
1024×768p@75	✓	✓	✓	✓	✓
1024×768p@85	✓	✓	✓	✓	✓
1152×864p@75	✓	✓	✗	✓	✓
1280×720p@23	✗	✓	✗	✓	✓

Transmitter's Supported Resolutions (Hz)	Input			Output	
	VGA	HDMI	DP	HDMI	HDBT
1280×720p@24		✓		✓	✓
1280×720p@25		✓	✓	✓	✓
1280×720p@29		✓	✓	✓	✓
1280×720p@30		✓	✓	✓	✓
1280×720p@50	✓	✓	✓	✓	✓
1280×720p@59		✓	✓	✓	✓
1280×720p@60	✓	✓	✓	✓	✓
1280×768p@60	✓	✓	✓	✓	✓
1280×768p@60 (RB)	✓	✓		✓	✓
1280×768p@75		✓	✓	✓	✓
1280×768p@85		✓	✓	✓	✓
1280×800p@60	✓	✓		✓	✓
1280×800p@60 (RB)	✓	✓		✓	✓
1280×800p@75	✓	✓		✓	✓
1280×800p@85		✓		✓	✓
1280×960p@60	✓	✓	✓	✓	✓
1280×960p@85		✓	✓	✓	✓
1280×1024p@60	✓	✓	✓	✓	✓
1280×1024p@75	✓	✓	✓	✓	✓
1280×1024p@85	✓	✓	✓	✓	✓
1360×768p@60		✓	✓	✓	✓
1366×768p@60 (RB)	✓	✓		✓	✓
1366×768p@60	✓	✓		✓	✓
1400×1050p@60		✓		✓	✓
1400×1050p@60 (RB)		✓		✓	✓
1440×900p@60	✓	✓		✓	✓

Transmitter's Supported Resolutions (Hz)	Input			Output	
	VGA	HDMI	DP	HDMI	HDBT
1440×900p@60 (RB)	✓	✓		✓	✓
1440×900p@75		✓		✓	✓
1600×900p@60 (RB)		✓		✓	✓
1600×1200p@60	✓	✓	✓	✓	✓
1600×1200p@65		✓		✓	✓
1600×1200p@70		✓		✓	✓
1600×1200p@75		✓		✓	✓
1600×1200p@85		✓		✓	✓
1680×1050p@60	✓	✓	✓	✓	✓
1680×1050p@60 (RB)	✓	✓		✓	✓
1920×1080p@23	✓	✓	✓	✓	✓
1920×1080p@24	✓	✓	✓	✓	✓
1920×1080p@25		✓	✓	✓	✓
1920×1080p@29		✓	✓	✓	✓
1920×1080p@30		✓	✓	✓	✓
1920×1080p@50	✓	✓	✓	✓	✓
1920×1080p@59		✓	✓	✓	✓
1920×1080p@60	✓	✓	✓	✓	✓
1920×1080i@50		✓	✓	✓	✓
1920×1080i@59		✓	✓	✓	✓
1920×1080i@60		✓	✓	✓	✓
1920×1200p@60 (RB)	✓	✓		✓	✓
2048×1080p@23		✓		✓	✓
2048×1080p@24		✓		✓	✓
2048×1080p@25		✓		✓	✓
2048×1080p@29		✓		✓	✓

Transmitter's Supported Resolutions (Hz)	Input			Output	
	VGA	HDMI	DP	HDMI	HDBT
2048×1080p@30		✓		✓	✓
2048×1080p@50		✓		✓	✓
2048×1080p@59		✓		✓	✓
2048×1080p@60		✓		✓	✓
3840×2160p@23		✓	✓	✓	✓
3840×2160p@24		✓	✓	✓	✓
3840×2160p@25		✓	✓	✓	✓
3840×2160p@29		✓	✓	✓	✓
3840×2160p@30		✓	✓	✓	✓
3840×2160p@50		✓	✓	✓	
3840×2160p@59		✓	✓	✓	
3840×2160p@60		✓	✓	✓	
3840×2160p@50 (4:2:0)		✓		✓	✓
3840×2160p@59 (4:2:0)		✓		✓	✓
3840×2160p@60 (4:2:0)		✓		✓	✓
4096×2160p@23		✓	✓	✓	✓
4096×2160p@24		✓	✓	✓	✓
4096×2160p@25		✓	✓	✓	✓
4096×2160p@29		✓	✓	✓	✓
4096×2160p@30		✓	✓	✓	✓
4096×2160p@50		✓	✓	✓	
4096×2160p@59		✓	✓	✓	
4096×2160p@60		✓	✓	✓	
4096×2160p@50 (4:2:0)		✓		✓	✓
4096×2160p@59 (4:2:0)		✓		✓	✓
4096×2160p@60 (4:2:0)		✓		✓	✓

8.2.2 Receiver's Resolutions

Receiver's Supported Resolutions (Hz)	Input		Output	
	HDBT	HDMI	Bypass HDMI	Scaled HDMI
640×480p@60	✓	✓	✓	
640×480p@72	✓	✓	✓	
640×480p@75	✓	✓	✓	
640×480p@85	✓	✓	✓	
720×400p@70	✓	✓	✓	
720×400p@85	✓	✓	✓	
720×480i@59	✓	✓	✓	
720×480i@60	✓	✓	✓	
720×480p@59	✓	✓	✓	
720×480p@60	✓	✓	✓	✓
720×576i@50	✓	✓	✓	
720×576p@50	✓	✓	✓	✓
800×600p@56	✓	✓	✓	
800×600p@60	✓	✓	✓	✓
800×600p@72	✓	✓	✓	
800×600p@75	✓	✓	✓	
800×600p@85	✓	✓	✓	
848×480p@60	✓	✓	✓	
1024×768p@60	✓	✓	✓	✓
1024×768p@70	✓	✓	✓	
1024×768p@75	✓	✓	✓	
1024×768p@85	✓	✓	✓	
1152×864p@75	✓	✓	✓	
1280×720p@23	✓	✓	✓	
1280×720p@24	✓	✓	✓	
1280×720p@25	✓	✓	✓	

Receiver's Supported Resolutions (Hz)	Input		Output	
	HDBT	HDMI	Bypass HDMI	Scaled HDMI
1280×720p@29	✓	✓	✓	
1280×720p@30	✓	✓	✓	
1280×720p@50	✓	✓	✓	✓
1280×720p@59	✓	✓	✓	
1280×720p@60	✓	✓	✓	✓
1280×768p@60	✓	✓	✓	✓
1280×768p@60 (RB)	✓	✓	✓	
1280×768p@75	✓	✓	✓	
1280×768p@85	✓	✓	✓	
1280×800p@60	✓	✓	✓	✓
1280×800p@60 (RB)	✓	✓	✓	
1280×800p@75	✓	✓	✓	
1280×800p@85	✓	✓	✓	
1280×960p@60	✓	✓	✓	
1280×960p@85	✓	✓	✓	
1280×1024p@60	✓	✓	✓	✓
1280×1024p@75	✓	✓	✓	
1280×1024p@85	✓	✓	✓	
1366×768p@60	✓	✓	✓	✓
1366×768p@60 (RB)		✓	✓	
1366×768p@60	✓	✓	✓	
1400×1050p@60	✓	✓	✓	✓
1400×1050p@60 (RB)	✓	✓	✓	
1440×900p@60	✓	✓	✓	✓
1440×900p@60 (RB)	✓	✓	✓	
1440×900p@75	✓	✓	✓	
1600×900p@60 (RB)	✓	✓	✓	

Receiver's Supported Resolutions (Hz)	Input		Output	
	HDBT	HDMI	Bypass HDMI	Scaled HDMI
1600×1200p@60	✓	✓	✓	✓
1600×1200p@65	✓	✓	✓	
1600×1200p@70	✓	✓	✓	
1600×1200p@75	✓	✓	✓	
1600×1200p@85	✓	✓	✓	
1680×1050p@60	✓	✓	✓	✓
1680×1050p@60 (RB)	✓	✓	✓	
1920×1080p@23	✓	✓	✓	
1920×1080p@24	✓	✓	✓	
1920×1080p@25	✓	✓	✓	
1920×1080p@29	✓	✓	✓	
1920×1080p@30	✓	✓	✓	
1920×1080p@50	✓	✓	✓	✓
1920×1080p@59	✓	✓	✓	
1920×1080p@60	✓	✓	✓	✓
1920×1080i@50	✓	✓	✓	✓
1920×1080i@59	✓	✓	✓	
1920×1080i@60	✓	✓	✓	✓
1920×1200p@60 (RB)	✓	✓	✓	✓
2560×1600p@60 (RB)				
2048×1080p@23	✓	✓	✓	
2048×1080p@24	✓	✓	✓	
2048×1080p@25	✓	✓	✓	
2048×1080p@29	✓	✓	✓	
2048×1080p@30	✓	✓	✓	
2048×1080p@50	✓	✓	✓	
2048×1080p@59	✓	✓	✓	

Receiver's Supported Resolutions (Hz)	Input		Output	
	HDBT	HDMI	Bypass HDMI	Scaled HDMI
2048×1080p@60	✓	✓	✓	
3840×2160p@23	✓	✓	✓	
3840×2160p@24	✓	✓	✓	✓
3840×2160p@25	✓	✓	✓	✓
3840×2160p@29	✓	✓	✓	
3840×2160p@30	✓	✓	✓	✓
3840×2160p@50		✓	✓	✓
3840×2160p@59		✓	✓	
3840×2160p@60		✓	✓	✓
3840×2160p@50 (4:2:0)	✓	✓	✓	✓
3840×2160p@59 (4:2:0)	✓	✓	✓	
3840×2160p@60 (4:2:0)	✓	✓	✓	✓
4096×2160p@23	✓	✓	✓	
4096×2160p@24	✓	✓	✓	
4096×2160p@25	✓	✓	✓	
4096×2160p@29	✓	✓	✓	
4096×2160p@30	✓	✓	✓	
4096×2160p@50		✓	✓	
4096×2160p@59		✓	✓	
4096×2160p@60		✓	✓	
4096×2160p@50 (4:2:0)	✓	✓	✓	
4096×2160p@59 (4:2:0)	✓	✓	✓	
4096×2160p@60 (4:2:0)	✓	✓	✓	

8.2.3 Color Sapce Conversions

Resolution (Hz)	Input		Output	
	Color Space	Bit Depth	Color Space	Bit Depth
4K@23/24/25/29/30	RGB	8	RGB	8
	RGB	10	RGB	8
	RGB	12	RGB	8
	YUV 4:4:4	8	YUV 4:4:4	8
	YUV 4:4:4	10	YUV 4:4:4	8
	YUV 4:4:4	12	YUV 4:4:4	8
4K@50/59/60	RGB	8	YUV 4:2:0	8
	YUV 4:4:4	8	YUV 4:2:0	8
	YUV 4:2:0	8	YUV 4:2:0	8
	YUV 4:2:0	10	YUV 4:2:0	8
	YUV 4:2:0	12	YUV 4:2:0	8

8.2.4 Cable Specifications

Cable Type	Cable Length	Supported Video Format
Cat.5e/6/6a/7	100 meters	Full HD video: Up to 1080p@60Hz, 12-bit color Data rates lower than 5.3Gbps or below 225MHz TMDS clock
Cat.5e/6/6a/7	70 meters	Ultra HD video: 4K@24/25/30Hz & 4K@50/60Hz (YUV 4:2:0), 8-bit color Data rates higher than 5.3Gbps or above 225MHz TMDS clock

8.3 Application Notes

- ▶ The unit's default IP address is 192.168.1.50.
- ▶ 4K UHD sources or equivalently high-bandwidth signals require an appropriate compatible display and Premium High Speed HDMI or certified DisplayPort 1.2 cables in order to achieve the best image quality.
- ▶ HDBaseT requires Cat.5e, Cat.6, or Cat.7 certified cable. Cat.6 or better is highly recommended.
- ▶ The collaboration Transmitter's analog audio input can only be embedded into video sources connected to the Transmitter (VGA, HDMI, DP). It is not possible to embed the analog audio into the HDMI source connected to the Receiver.
- ▶ Due to the large amount of data that needs to be processed, the WebGUI's Event, Macro, Command, and Device tabs do not automatically update while they are being viewed. Please manually refresh or reload the web page to immediately update the displayed info (press F5 in most browsers).
- ▶ The Command Data field supports up to a maximum of 256 characters. Note that some captured IR commands might exceed this limit, and their data will be truncated.
- ▶ The serial port (RS-232) on the Transmitter may be used for events, however, the baud rate is locked at 115200bps to maintain support for controlling the Transmitter itself via RS-232.
- ▶ Listening for multiple Serial Port (RS-232) events is supported, however, all active events using the Receiver's RS-232 port must use the same baud rate. It is not possible for multiple active events to listen at different baud rates.
- ▶ IR receiver events can select Local (Transmitter) or Remote (Receiver) to identify the location of the IR interface to use.
- ▶ Some VGA and DisplayPort sources might not support the "Plug In", "Plug Out" or "Plug Change" event conditions because the 5V line used for input detection is optional on those interfaces.
- ▶ The Auto Audio Switch function makes its decision based on if the signal contains audio packets or not. If the source contains audio packets, but it is set to mute or volume equals 0, then it will still determine that audio is present.

9. ACRONYMS

ACRONYM	COMPLETE TERM
Cat.5e	Category 5 (enhanced) Cable
Cat.6	Category 6 Cable
Cat.7	Category 7 Cable
CEC	Consumer Electronics Control
CLI	Command Line Interface
DP	DisplayPort
DVI	Digital Visual Interface
EDID	Extended Display Identification Data
GUI	Graphical User Interface
HD	High-Definition
HDCP	High-bandwidth Digital Content Protection
HDMI	High-Definition Multimedia Interface
HDR	High Dynamic Range
HTTP	HyperText Transfer Protocol
IP	Internet Protocol
IR	Infrared
LAN	Local Area Network
LPCM	Linear Pulse-Code Modulation
OSD	On-Screen Display
PC	Personal Computer
PoH	Power over HDBaseT
UHD	Ultra-High-Definition
USB	Universal Serial Bus
VGA	Video Graphics Array (640×480@60Hz)
WUXGA	Wide Ultra Extended Graphics Array (1920×1200@60Hz)



CYPRESS TECHNOLOGY CO., LTD.

www.cypress.com.tw