



CMSI-4H4CV

HDBaseT™ 4×4 HDMI Matrix over CAT5e/6/7



Operation Manual

DISCLAIMERS

The information in this manual has been carefully checked and is believed to be accurate. Cypress Technology assumes no responsibility for any infringements of patents or other rights of third parties which may result from its use.

Cypress Technology assumes no responsibility for any inaccuracies that may be contained in this document. Cypress also makes no commitment to update or to keep current the information contained in this document.

Cypress Technology reserves the right to make improvements to this document and/or product at any time and without notice.

COPYRIGHT NOTICE

No part of this document may be reproduced, transmitted, transcribed, stored in a retrieval system, or any of its part translated into any language or computer file, in any form or by any means—electronic, mechanical, magnetic, optical, chemical, manual, or otherwise—without express written permission and consent from Cypress Technology.

© Copyright 2011 by Cypress Technology.

All Rights Reserved.

Version 1.1 August 2011

TRADEMARK ACKNOWLEDGMENTS

All products or service names mentioned in this document may be trademarks of the companies with which they are associated.





SAFETY PRECAUTIONS

Please read all instructions before attempting to unpack, install or operate this equipment and before connecting the power supply.

Please keep the following in mind as you unpack and install this equipment:

- Always follow basic safety precautions to reduce the risk of fire, electrical shock and injury to persons.
- To prevent fire or shock hazard, do not expose the unit to rain, moisture or install this product near water.
- Never spill liquid of any kind on or into this product.
- Never push an object of any kind into this product through any openings or empty slots in the unit, as you may damage parts inside the unit.
- Do not attach the power supply cabling to building surfaces.
- Use only the supplied power supply unit (PSU). Do not use the PSU if it is damaged.
- Do not allow anything to rest on the power cabling or allow any weight to be placed upon it or any person walk on it.
- To protect the unit from overheating, do not block any vents or openings in the unit housing that provide ventilation and allow for sufficient space for air to circulate around the unit.

REVISION HISTORY

VERSION NO.	DATE DD/MM/YY	SUMMARY OF CHANGE
VR0	13/11/12	Preliminary Release
VR1	04/06/13	RS-232 & Telnet's Set IP Command
VS1	04/11/13	Separated 4x4 and 8x8 Manuals



CONTENTS

1. Introduction	1
2. Applications	1
3. Package Contents	1
4. System Requirements	2
5. Features	2
6. Operation Controls and Functions	3
6.1 Front Panel.....	3
6.2 Rear Panel	4
6.3 Side Panel	5
6.4 Remote Control.....	6
6.5 IR Cable Pin Assignment	7
6.6 RS-232 Pin Assignment	7
6.7 RS-232 and Telnet Commands	8
6.8 Telnet Control	9
6.9 Web GUI Control.....	11
7. Connection Diagram	14
8. Specifications	15
8.1 Technical Specifications	15
8.2 CAT5e/6/7 Cable Specification	16
9. Acronyms	16





1. INTRODUCTION

The HDBaseT™ 4 by 4 HDMI Matrix over CAT5e/6/7 supports the transmission of video (resolutions up to 1080p Full HD and 1920×1200@60Hz) and multi-channel digital audio from four high definition sources to four outputs over a single CAT5e/6/7 cable (up to 100m) for each output. It supports high resolution digital audio formats such as LPCM 7.1CH, Dolby TrueHD, Dolby Digital Plus and DTS-HD Master Audio as well as 3D content that can be displayed when connecting a 3DTV and 3D source. The matrix can be controlled via IR, RS-232, Telnet or Web GUI. Power over Ethernet (PoE) support means that compatible receivers do not need their own separate power supplies, allowing for greater flexibility in installations.

2. APPLICATIONS

- HDMI Matrix System
- Video/TV wall display and control
- Security surveillance and control
- Commercial advertising, display and control
- University lecture hall, display and control
- Retail sales and demonstration

3. PACKAGE CONTENTS

- 1×HDBaseT™ 4×4 HDMI Matrix over CAT5e/6/7
- 2×IR Extender
- 2×IR Blaster
- 1×IR Remote Control
- 2×24V/6.25A DC Power Adaptor (1 for PoE)
- Operation Manual

4. SYSTEM REQUIREMENTS

- HDMI equipped source devices, connect with HDMI cables or DVI equipped source, connect with DVI to HDMI cables
- HDMI equipped displays (TVs or monitors) or HDMI equipped AV receivers, connected with HDMI cables
- Industry standard CAT5e/6/7 cables
- HDBaseT™ Receivers (CH-506RX, CH-507RX or CH-1109RX)

5. FEATURES

- HDMI, HDCP1.1 and DVI compliant
- Supports HDMI 3D features
- Supports resolutions VGA~WUXGA and 480i~1080p dependent upon the output display's EDID settings
- Supports 3D signal display dependent upon the output display EDID settings
- Supports PoE (Power over Ethernet) on compatible receivers only
- Supports HDMI input up to 15 meters at 8-bit resolution or 10 meters at 12-bit resolution
- Supports bi-directional IR to and from input and output locations
- Supports control via RS-232, IR remote, on-panel buttons and IP (Telnet & Web GUI)
- 2U size design
- Supports external and internal EDID settings
- Supports LPCM 7.1CH, Dolby TrueHD, Dolby Digital Plus and DTS-HD Master Audio transmission

Note:

1. *The PoE function is designed for powering compatible receiver units only—non-PoE receivers will need their own power supply. Receivers of another brand may not be compatible.*
2. *Do not connect the LAN/CONTROL port to CAT outputs of this device.*

6. OPERATION CONTROLS AND FUNCTIONS

6.1 Front Panel

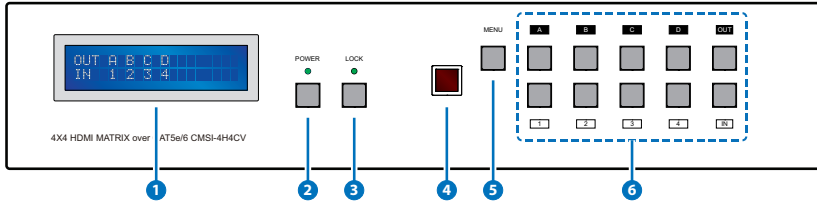

- 1 **LCM:** Displays the setting information of each input and output setting.
- 2 **POWER:** Press this button to power the device on/off. The LED will illuminate green when the power is on, red when it is in 'Standby' mode.
- 3 **LOCK:** Press this button to lock all the buttons on the panel; press again to unlock. The LED will illuminate green when locked.
- 4 **IR:** IR Receiver window (accepts the remote control signal of this device only) with IR frequency of 38kHz.
- 5 **MENU:** Press this button to access the LCM menu system, from here EDID settings can be managed and IP system settings are displayed.
- 6 **1~4/A~D and OUT/IN:** Press the OUT or IN button to select the output or input mode and then press the required number button to make the selection accordingly.

For example, if outputs A~B need to be set to input 1 and outputs C~D need to be set to input 2, then the following sequence of button presses need to be performed:

Press: OUT→A→B→IN→1→MENU,
and then press: OUT→C→D→IN→2→MENU.

Note: If the MENU button is not pressed the selection will not be changed.

6.2 Rear Panel

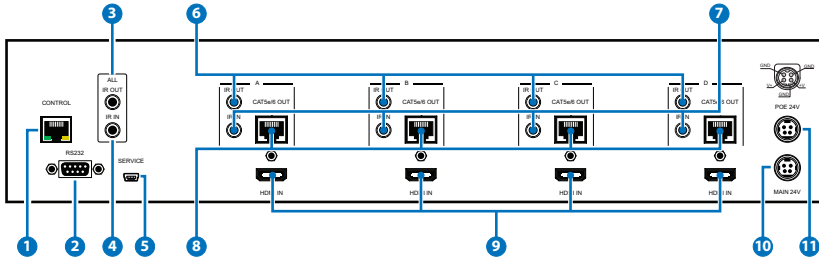

- 1 CONTROL:** This port is the link for Telnets or Web GUI controls, connect to an active Ethernet link with an RJ45 terminated cable (for further details on IP control, please refer to sections 6.8 & 6.9).

Warning: Please do not connect this port directly to the PC/Laptop as the Telnets function will not work.
- 2 RS-232:** Connect to a PC or control system with D-Sub 9-pin cable for control of the matrix via RS-232 commands (please refer to Section 6.7 for a list of commands).
- 3 ALL IR OUT:** Connect to the IR blaster for IR signal transmission to the source devices. Place the IR blaster in direct line-of-sight of the equipment to be controlled. All signals received from the display side will be relayed to the source devices.
- 4 ALL IR IN:** Connect to the IR extender for IR signal reception. Ensure that the remote being used is within the direct line-of-sight of the IR extender. It will transmit all signals received through the IR ALL OUT.
- 5 SERVICE:** Manufacturer use only.
- 6 IR OUT A~D:** Connect to the IR blasters for IR signal transmission. Place the IR blaster in direct line-of-sight of the equipment to be controlled. It will transmit the IR signal received from the receiver side according to the selected input.
- 7 IR IN 1~4:** Connect to the IR extenders for IR signal reception. Ensure that the remote being used is within the direct line-of-sight of the IR extender. It will send out the IR signal received to the selected IR OUT (A-D).
- 8 CAT5e/6/7 OUT A~D:** Connect the CAT outputs to the CAT input port of the receiver units with a single CAT5e/6/7 cable for HDMI Audio/Video and IR control signal transmission.

Warning: Please do not connect the CAT5e/6/7 outputs to the receiver's LAN port.

- 9 **HDMI IN 1~4:** Connect to the HDMI source devices such as a DVD player or a Set-top Box with HDMI cables or DVI to HDMI cables.
- 10 **DC 24V:** Connect the 24 V DC power supply to the unit and plug the adaptor into an AC outlet.
- 11 **PoE 24V:** Connect the 24V PoE power supply into the unit and plug the adaptor into an AC outlet. This unit will mainly power PoE (Power over Ethernet) capable receiver units.

6.3 Side Panel

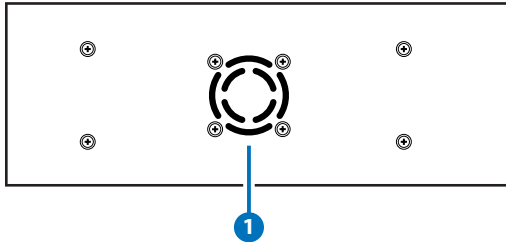

- 1 **Fan Ventilator:** These are air ventilation areas, DO NOT block these areas or cover it with any object. Please allow adequate space around the unit for air circulation.

6.4 Remote Control

1 POWER: Press this button to switch the device 'ON' or set it to standby mode.

2 IN: Input selection 1~4.

3 OUT: Output selection A~D.

Note:

1. When the IR remote is used in the Output Zone the user only needs to select the desired input (1~8)
2. 5~8 and E~H buttons are not functioning.

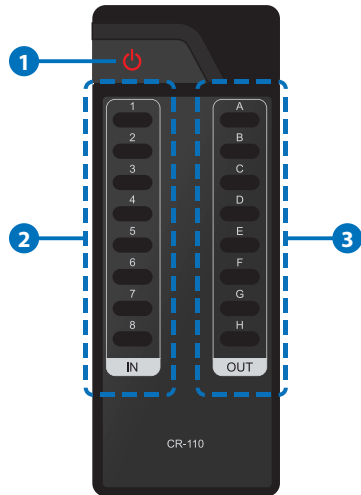

6.5 IR Cable Pin Assignment

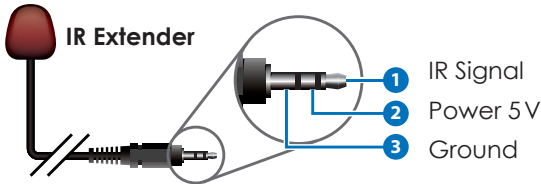
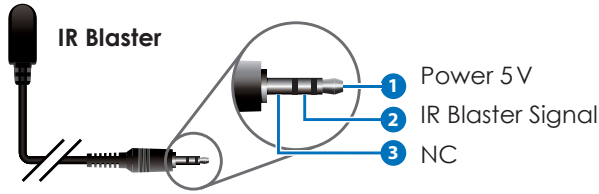

6.6 RS-232 Pin Assignment

HDMI MATRIX	
PIN	Assignment
1	NC
2	Tx
3	Rx
4	NC
5	GND
6	NC
7	NC
8	NC
9	NC



REMOTE CONTROL CONSOLE	
PIN	Assignment
1	NC
2	Rx
3	Tx
4	NC
5	GND
6	NC
7	NC
8	NC
9	NC

Baud Rate: 19200 bps

Data Bit: 8-bit

Parity: None

Stop Bit: 1-bit

Flow Control: None

6.7 RS-232 and Telnet Commands

COMMAND	DESCRIPTION
A1~A4	Switch Output A to 1~4
B1~B4	Switch Output B to 1~4
C1~C4	Switch Output C to 1~4
D1~D4	Switch Output D to 1~4
ABCD...1~ABCD...4	Switch Output ABCD... to 1~4 at the same time
SETIP <IP> <SubNet> <GW>	Setting IP. SubNet. GateWay<Static IP>
RSTIP	IP configuration was reset to factory defaults<DHCP>
IPCONFIG	Display the current IP config
P0	Power Off
P1	Power On
I1~I4	Switch all the output to 1~4
ST	Display the current matrix state and firmware version
RS	System Reset to D4
EM	Setting EDID MODE. 1-STD 2-TV.
?	Display all available commands
QUIT	Exit (Telnet only)

Note:

1. Commands will not be executed unless followed by a carriage return. Commands are case-insensitive.
2. When the Telnet connection is idle for 10 minutes it will be automatically disconnected.
3. The TV EDID setting will always follow output port 1's EDID setting regardless of the output change.
4. EDID setting switching will execute immediately.

6.8 Telnet Control

Before attempting to use the telnet control, please ensure that both the Matrix (via the 'LAN /CONTROL' port) and the PC/Laptop are connected to the same active networks.

To access the telnet control in Windows 7, click on the 'Start' menu and type "cmd" in the Search field then press enter.

Under Windows XP go to the 'Start' menu and click on "Run", type "cmd" with then press enter.

Under Mac OS X, go to Go→Applications→Utilities→Terminal

See below for reference.

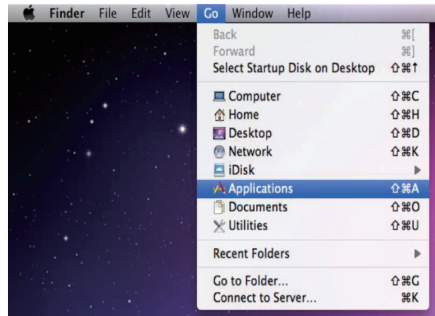

Once in the command line interface (CLI) type "telnet", then the IP address of the unit and "23", then hit enter.

Note: The IP address of the Matrix can be displayed on the device's LCM monitor by pressing the Menu button twice.

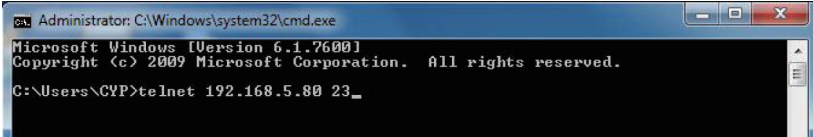

```
Administrator: C:\Windows\system32\cmd.exe
Microsoft Windows [Version 6.1.7600]
Copyright (c) 2009 Microsoft Corporation. All rights reserved.
C:\Users\CYP>telnet 192.168.5.80 23_
```

This will bring us into the device which we wish to control. Type "HELP" to list the available commands.

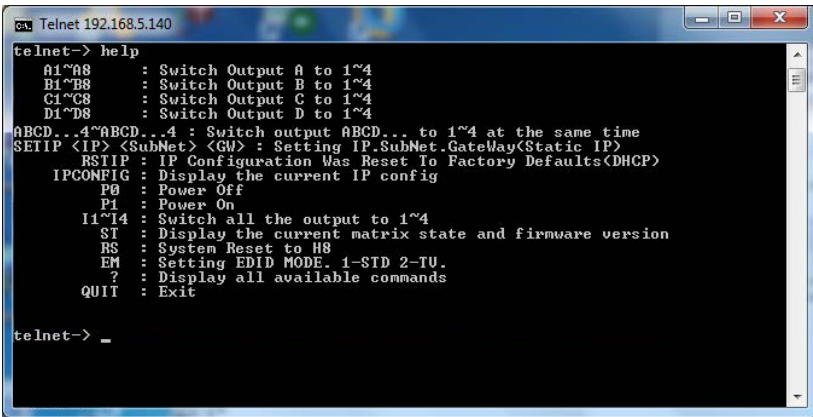

```
Telnet 192.168.5.140
telnet-> help
A1~A8      : Switch Output A to 1~4
B1~B8      : Switch Output B to 1~4
C1~C8      : Switch Output C to 1~4
D1~D8      : Switch Output D to 1~4
ABCD...4~ABCD...4 : Switch output ABCD... to 1~4 at the same time
SETIP <IP> <SubNet> <GW> : Setting IP.SubNet.GateWay<Static IP>
RSTIP      : IP Configuration Was Reset To Factory Defaults<DHCP>
IPCONFIG   : Display the current IP config
P0         : Power Off
P1         : Power On
I1~I4     : Switch all the output to 1~4
ST        : Display the current matrix state and firmware version
RS        : System Reset to H8
EM        : Setting EDID MODE. 1-STD 2-TU.
?         : Display all available commands
QUIT      : Exit

telnet-> _
```

Type "IPCONFIG" To show all IP configurations. To reset the IP, type "RSTIP" and to use a set static IP, type "SETIP" (For a full list of commands, see Section 6.7).

Note: Commands will not be executed unless followed by a carriage return. Commands are not case-sensitive. If the unit's IP is changed then the IP Address required for Telnet access will also change accordingly.



6.9 Web GUI Control

On a PC/Laptop that is connected to the same active network as the Matrix, open a web browser and type the device's IP address on the web address entry bar. The browser will display the device's status, control and User setting pages.

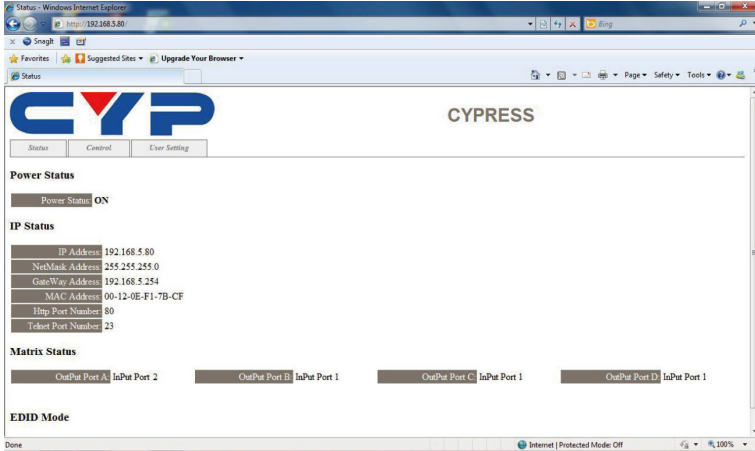

Click on the 'Control' tab to control power, input/output ports, EDID and reset mode.

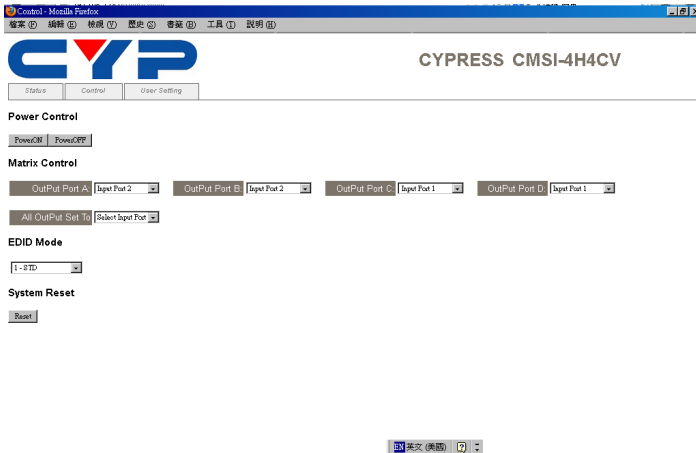

Clicking on the 'User Setting' tab allows you to reset the IP configuration. The system will ask for a reboot of the device when any of the settings are changed. The IP address needed to access the Web GUI control will also need to be changed accordingly on the web address entry bar.

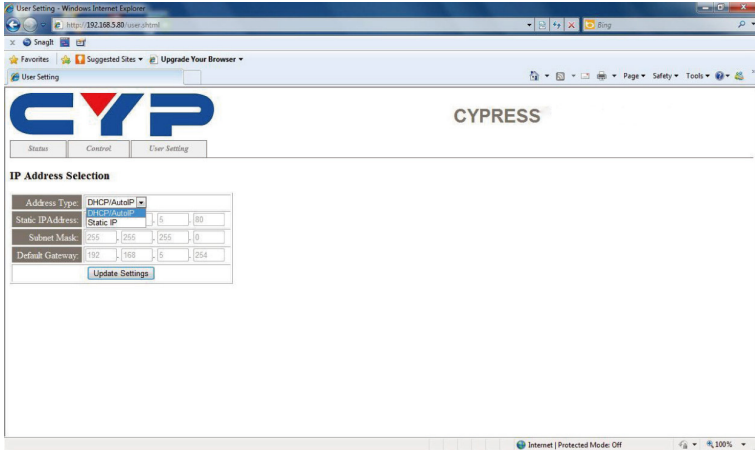

7. CONNECTION DIAGRAM

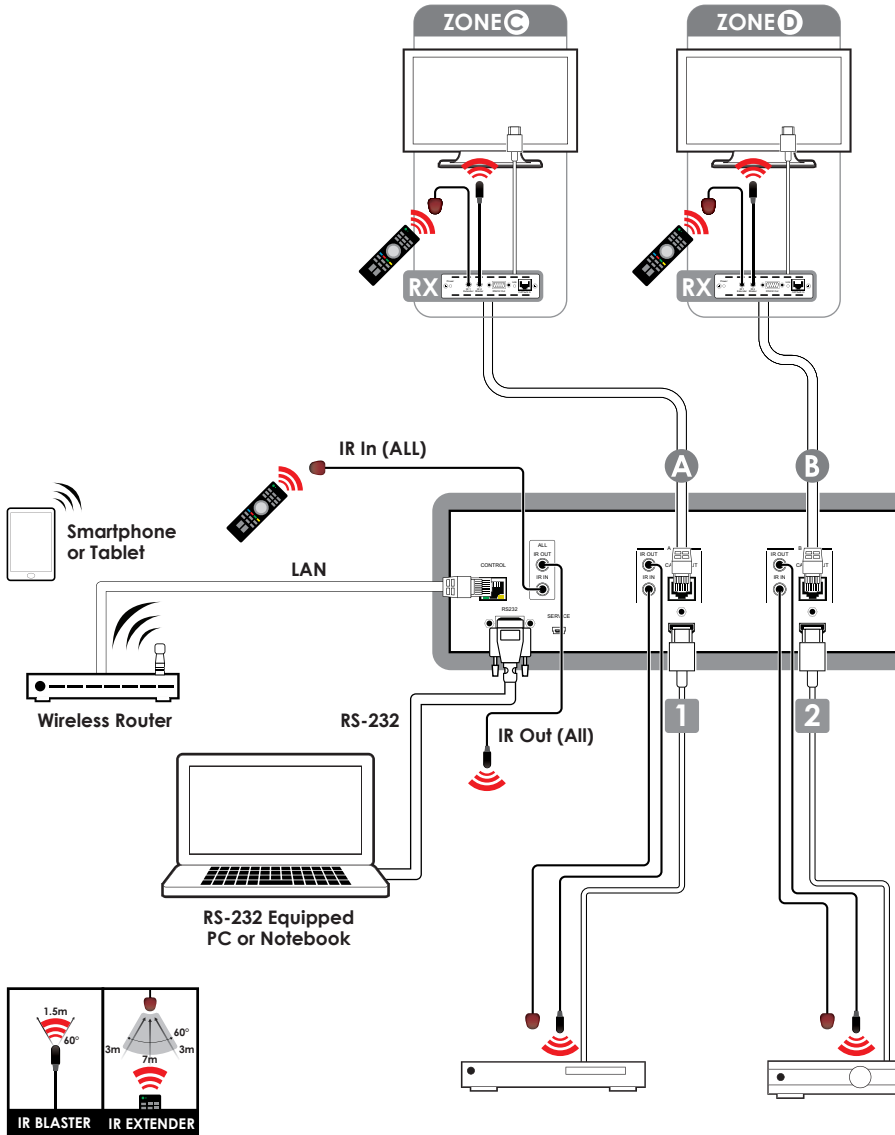

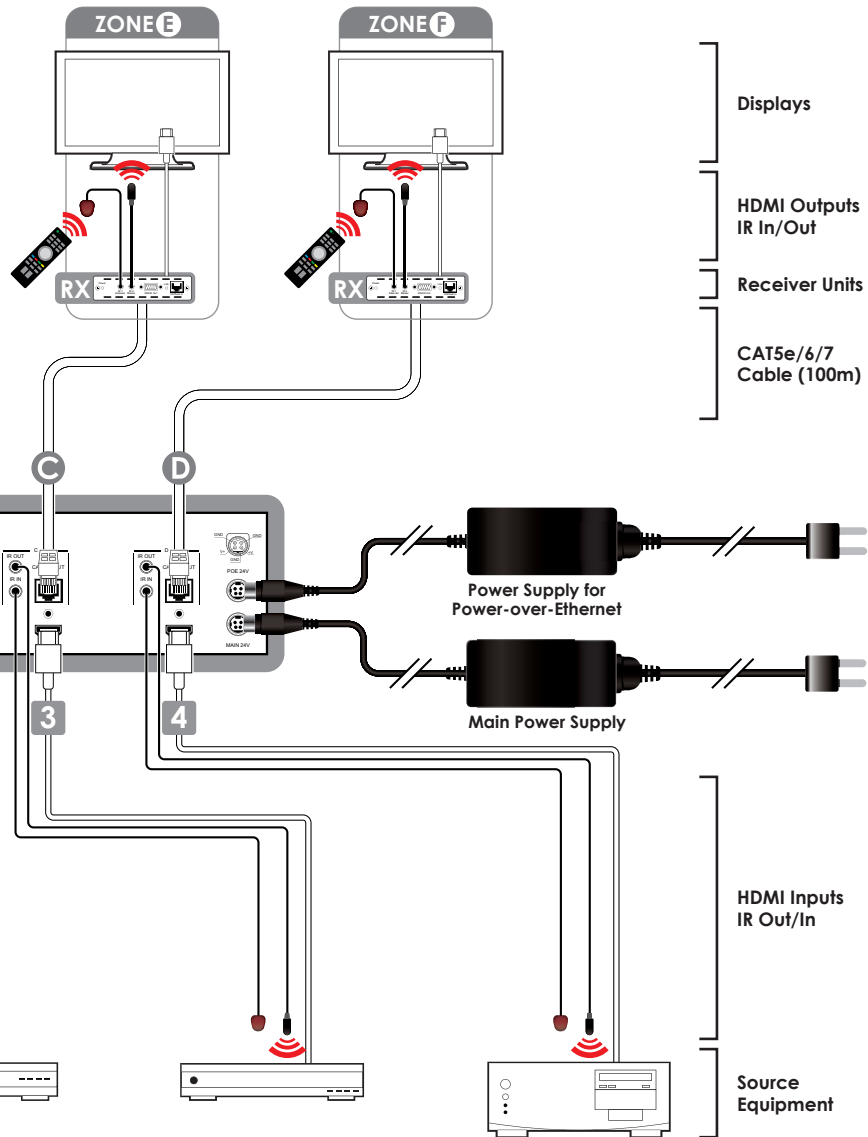



8. SPECIFICATIONS

8.1 Technical Specifications

Video Bandwidth	225 MHz/6.75 Gbps
Input Ports	4×HDMI, 5×IR Extender, 1×RS-232, 1×RJ-45 (Control), 1×Mini USB Type B (For firmware updated only)
Output Ports	4×CAT5e/6/7, 5×IR Blaster
IR Frequency	30~50 kHz
Supported Resolutions	HDTV: 480i~1080p50/60 & 1080p24 PC: VGA~WXGA
HDMI Input Cable Length	15 m (1080p@8-bit) 10 m (1080p@12-bit)
Audio Sampling Rate	Up to 192 kHz
ESD Protection	Human-body Model: ± 8kV (Air-gap discharge) ± 4kV (Contact discharge)
Power Supply	24 V/6.25 A DC (US/EU standards, CE/FCC/UL certified)
Dimensions	438 mm (W)×255 mm (D)×93 mm (H)
Weight	4238 g
Chassis Material	Metal
Color	Black
Operating Temperature	0 °C~40 °C/32 °F~104 °F
Storage Temperature	-20 °C~60 °C/-4 °F~140 °F
Relative Humidity	20~90 % RH (non-condensing)
Power Consumption	42 W/TX (Main), 27 W/RX (PoE)

8.2 CAT5e/6/7 Cable Specification

CABLE TYPE	RANGE	PIXEL CLOCK RATE	VIDEO DATA RATE	SUPPORTED VIDEO
CAT5e/6/7	100m	≤225 MHz	≤5.3 Gbps (HD Video)	Up to 1080p, 60 Hz, 36 bits, 3D (data rates lower than 5.3 Gbps or below 225 MHz TMDS clock).
	70m	>225 MHz	> 5.3 Gbps (Ultra HD Video)	4K×2K, 30Hz video formats

9. ACRONYMS

ACRONYM	COMPLETE TERM
CLI	Command Line Interface
DTS	Digital Theater System
DVI	Digital Visual Interface
EDID	Extended Display Identification Data
GUI	Graphical User Interface
HDCP	High-bandwidth Digital Content Protection
HDMI	High-Definition Multimedia Interface
HDTV	High-Definition Television
LCM	Liquid Crystal Module
USB	Universal Serial Bus
VGA	Video Graphics Array
WUXGA	Widescreen Ultra Extended Graphics Array



CYPRESS TECHNOLOGY CO., LTD

Home page: <http://www.cypress.com.tw>

20120518 MPM-CMSI8H8CV